



Architectural Ironmongery Ltd

ARCHITECTURAL HARDWARE

Knex Architectural Ironmongery is at the forefront of specifying and supplying architectural ironmongery and access control solutions to the public and building trade.

With over 25 years experience within the distribution of ironmongery we understand the importance of a complete tailor made service to suit your individual requirements, ensuring a high level of service and product to a price conscious market.

Our ethos:

Simple...

Quality and service are the most important aspects for any project, these are key in allowing us to be diverse and not focus on any specific sector.

Our primary objective is to provide a responsive, friendly and professional service tailored to suit the needs of each client regardless of building size or type.

We try not to bring fixed ideas to the table, every client and every project is unique and needs to be approached differently.

Key points of service:

- **Design Input:** Providing a specification service on your behalf for your client or architect including presentation show boards and samples for client approval.
- **Scheduling:** Providing a comprehensive ironmongery scheduling service from tender through to secured stage covering all DDA access control and fire requirements. Using state of the art scheduling software featuring a door by door scheduling system offering a friendly breakdown of each of your doors ironmongery requirements.
- **Onsite support:** Supporting your key members of staff on site with issues that may arise through design or functioning issues. Ensuring a smooth transition of products to site.
- **Distribution:** Tailor made distribution of your goods whether it's door itemised or bulk packed. We offer a next day delivery service using a major national courier, ensuring deliveries to all parts of the UK. Cut off point upto 6pm.



Key to Symbols



KITEMARK

Kitemark is the worlds premier symbol of trust, integrity and quality. Manufacturers having this associated with their product or service will reassure customers and specifiers alike that they have satisfied the most rigorous of quality processes.



BS EN 1634 PART1:2000

BS EN 1634 is the European Fire Safety Standard for determining the fire resistance of door and shutter assemblies, including door hardware:

FD30 - 30 Minute Fire Doors



FD60 - 60 Minute Fire Doors

FD30/60 - 30 and 60 Minute Fire Doors



FIRE DOORS HARDWARE

The UK Construction Products Directive requires that door hardware for use on fire doors be safe and durable.



CE MARKING

CE Marking is certification to the highest levels of attestation required by the Construction Products Directive. The CE mark indicates that the product has been successfully 3rd party performance/fire tested and that the producing factory has passed stringent Factory Production Control audits, carried out by a UKAS notified certification body.

CERTIFIRE

Certifire is an independent third party scheme providing high quality, voluntary, product conformity for the passive fire sector. Certifire is product certification at a higher level than CE. Additional requirements are ISO9001:2000 certification, independent audit testing and a comprehensive field of application document based on carefully chosen tests. Designed to give confidence to specifiers, enforcement authorities and building owners/occupiers, the Certifire scheme is recognised by regulatory authorities both in the UK and overseas.



SECURED BY DESIGN

Secured by design is the UK Policed flagship initiative supporting the principles of "designing out crime" prevention and security standards for a range of applications and products showing their logo have met the standards identified by this organisation. A full list of licensed products can be found on the website www.securedbydesign.com



BS 8300

BS 8300 is the design of buildings and their approaches to meet the needs of disabled people.



BS EN 1154

BS EN 1154

BS EN 1154 is the British/European standard requirements and testing methods covering controlled door closing devices.



BS EN 1906

BS EN 1906

BS EN 1906 is the British/European standard requirements and testing methods covering lever handles and knob furniture.



BS EN 1935

BS EN 1935

BS EN 1935 is the British/European standard requirements and testing methods covering single axis hinges.



BS EN 1125

BS EN 1125

BS EN 1125 is the British/European standard requirements and testing methods covering panic exit devices operated by a horizontal bar.



BS EN 179

BS EN 179

BS EN 179 is the British/European standard requirements and testing methods covering panic exit devices operated by a lever handle or push pad.



BS EN 12209

BS EN 12209

BS EN 12209 is the British/European standard requirements and testing methods covering locks, latches and locking plates.



BS EN 1303

BS EN 1303:2005 BUILDING HARDWARE CYLINDERS FOR LOCKS

BS EN 1303 is the British/European standard requirements and testing methods covering cylinders for locks.



25 Year Mechanical Guarantee



The Guild of Architectural Ironmongers



10 Year Mechanical Guarantee



Master Locksmiths Association



5 Year Mechanical Guarantee

Care Instructions

BLACK ANTIQUE

Iron in any form is vulnerable to rusting. During our finishing process we make every effort to cover all areas of the product by first black zinc plating and then powder coating.

Where obvious abrasive areas of moving parts are evident an occasional light oiling is recommended. To remove harmful deposits which will cause corrosion we advise that the product is regularly wiped over with a lightly oiled cloth.

BRASS PRODUCTS

Our products are protected by the most advanced lacquer available and under normal circumstances should give many years service. They should be cleaned with a cloth moistened with soapy water or alternatively wiped over with a soft cloth with beeswax or a gentle non-abrasive quality car wax. UNDER NO CIRCUMSTANCES USE ANY FORM OF METAL CLEANER OR AEROSOL SPRAYS.

However, after a period of time the lacquer coating, especially on external fittings, can suffer a possible breakdown. Therefore, the life of the lacquer is beyond the manufacturer's control and cannot be guaranteed. When the lacquer coating has broken down, remove the brass fittings and coat using a soft brush with acetone thinner e.g. "Nitramores" according to the manufacturer's instructions. Completely dry the product using a soft cloth and metal polish, such as "Brasso" or "Duraglit". At this stage the product can either be re-lacquered or polished as and when required.

A fresh coat of lacquer may be applied but we strongly recommend that, especially for external use, you should leave the item unacquered.

CHROME PRODUCTS

Our quality chrome products are virtually maintenance free. However, deposits will accumulate especially on external fittings. We therefore recommend regular cleaning with a soft cloth and non-abrasive wax polish. This will ensure the original appearance is maintained.

FLORENTINE BRONZE

These products are lacquered and should be treated in the same way as brass. As the bronze is an applied finish we would expect it to wear over time, enhancing the antique effect.





































STAINLESS BRASS PVD

These products have an advanced vacuum treated process and we can offer a full 25-year replacement guarantee with the exclusive Stainless Brass finish.

The technology involved in this process renders the surface impervious to damage in normal use including oxidation, wear and abrasion.

All lacquered brass items require regular cleaning with non-abrasive wax polish. We recommend the removal of surface dirt by dusting with a soft cloth. Stubborn stains can be removed with the use of white spirit, similar spirit based products or a quality non-abrasive car wax polish.

Key to Finishes

BA 	Black Antique	PLG 	Plain White/Gold
BEP 	Black Electro Plated	PLW 	Plain White/Polished Brass
BL 	Black	PLWCP 	Plain White/Polished Chrome
BN 	Black Nickel	P/L 	Polished/Lacquered
BSS 	Bright Stainless Steel	PVD 	Stainless Brass
BSS/SSS 	Bright Stainless Steel/Satin Stainless Steel	PWCP 	Porcelain White/Polished Chrome
CP 	Polished Chrome	PWSC 	Porcelain White/Satin Chrome
CPSC 	Polished Chrome/Satin Chrome	SA 	Silver Anodised
CPSN 	Polished Chrome/Satin Nickel	SAA 	Satin Anodised Aluminium
CPSS 	Polished Chrome/Stainless Steel	SB 	Satin Brass
EB 	Electro Brassed	SBPB 	Satin Brass/Polished Brass
FB 	Florentine Bronze	SC 	Satin Chrome
GA 	Gold Anodised	SCCP 	Satin Chrome/Polished Chrome
GALV 	Galvanised	SCOL 	Self Colour
GN 	Green	SN 	Satin Nickel
ICFB 	Ivory Crackle Glaze/Florentine Bronze	SNPN 	Satin Nickel/Polished Nickel
MCCP 	Midnight Blue Crackle/Polished Chrome	SS 	Satin Stainless Steel
NP 	Nickel Plate	SSCP 	Satin Stainless Steel/Polished Chrome
PAA 	Polished Anodised Aluminium	SSS 	Satin Stainless Steel
PB 	Polished Brass	SSSC 	Satin Stainless Steel/Satin Chrome
PBKCP 	Porcelain Black/Polished Chrome	SV 	Silver
PB/SB 	Polished Brass/Satin Brass	W 	White
PCB 	Powder Coat Black	WOSC 	Wood Oak/Satin Chrome
PCW 	Powder Coat White	WPB 	White Brass
PG 	Polished Gold	WWPB 	Wood Walnut/Polished Brass
		ZP 	Zinc Plate



Levers on Rose	8
Levers on Backplate	44
Delamain Knob Furniture	69
Ice Crystal Knob Furniture	82
Classical Knob Furniture	85
External Door Furniture	90
Brass Pull Handles	116
Window Fittings	129
Accessories	145
Carlisle Brass Hinges	201
DeL'eau Bathroom	205
Ludlow Foundries	227
Eurospec Hinges	258
Panic Hardware	268
Door Closers	272
Locks	274
Cylinders	292
Steelworx Stainless Steel	314
Designer Pull Handles	360
Aluminium Collection	363

SEROZZETTA RANGE

Levers on Rose



SZC010

UNO

Lever on Round Rose
Press-on-Rose

Dimensions (mm):

Rose:	51 Dia.
Rose Thickness:	10
Projection:	68
Lever Length:	109



(B)



SZC020

DOS

Lever on Round Rose
Press-on-Rose

Dimensions (mm):

Rose:	51 Dia.
Rose Thickness:	10
Projection:	69
Lever Length:	113



(B)



SZC030

TRES

Lever on Round Rose
Press-on-Rose

Dimensions (mm):

Rose:	51 Dia.
Rose Thickness:	10
Projection:	69
Lever Length:	113



(B)

Serozzetta levers are supplied with bolt through fixings only and should be used in conjunction with BTL's on P197 and Eurospec locks. For matching escutcheons SZC001-3 see P145. For matching bathroom turn SZC004 see P146.

**SZC040****CUATRO**

Lever on Round Rose
Press-on-Rose

Dimensions (mm):

Rose:	51 Dia.
Rose Thickness:	10
Projection:	67
Lever Length:	113



CP



SC

**SZC050****CINCO**

Lever on Round Rose
Press-on-Rose

Dimensions (mm):

Rose:	51 Dia.
Rose Thickness:	10
Projection:	62
Lever Length:	109



CP



SC

**SZC330****TREINTA**

Lever on Round Rose
Press-on-Rose

Dimensions (mm):

Rose:	51 Dia.
Rose Thickness:	10
Projection:	62
Lever Length:	115



CP



SC

SEROZZETTA RANGE

Levers on Rose

Serozzetta



SZC340

CUARENTA

Lever on Round Rose
Press-on-Rose

Dimensions (mm):

Rose:	51 Dia.
Rose Thickness:	10
Projection:	67
Lever Length:	124



CP



SC



Serozzetta levers are supplied with bolt through fixings only and should be used in conjunction with BTLs on P197 and Eurospec locks. For matching escutcheons SZC001-3 see P145. For matching bathroom turn SZC004 see P146.

**SZM014****VALIANT**

Lever on Round Rose
2 Part Screw-on-Rose

Dimensions (mm):

Rose:	51 Dia.
Rose Thickness:	10
Projection:	45
Lever Length:	140



CP



CPSN

**SZM025****BREEZE**

Lever on Round Rose
2 Part Screw-on-Rose

Dimensions (mm):

Rose:	51 Dia.
Rose Thickness:	10
Projection:	55
Lever Length:	140



CP

**SZM026****VOGUE**

Lever on Round Rose
2 Part Screw-on-Rose

Dimensions (mm):

Rose:	51 Dia.
Rose Thickness:	10
Projection:	57
Lever Length:	144



CP



CPSN



Serozzetta levers are supplied with bolt through fixings only and should be used in conjunction with BTLs on P197 and Eurospec locks. For matching escutcheons SZM001-3 see P147. For matching bathroom turn SZM004 see P149.

SEROZZETTA M RANGE

Levers on Rose



SZM100

LUNA

Lever on Round Rose
2 Part Screw-on-Rose

Dimensions (mm):

Rose:	51 Dia.
Rose Thickness:	10
Projection:	55
Lever Length:	120



CP



SC



SZM110

AZUL (Dual Finish)

Lever on Round Rose
2 Part Screw-on-Rose

Dimensions (mm):

Rose:	51 Dia.
Rose Thickness:	10
Projection:	60
Lever Length:	126

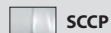

SCCP



SZM130

STYLE

Lever on Round Rose
2 Part Screw-on-Rose

Dimensions (mm):

Rose:	51 Dia.
Rose Thickness:	10
Projection:	60
Lever Length:	110



CP



SC

Serozzetta levers are supplied with bolt through fixings only and should be used in conjunction with BTL's on P197 and Eurospec locks. For matching escutcheons SZM001-3 see P147. For matching bathroom turn SZM004 see P149.



SZM160

TREND (Dual Finish)
Lever on Round Rose
2 Part Screw-on-Rose

(B)

Dimensions (mm):

Rose: 51 Dia.
Rose Thickness: 10
Projection: 65
Lever Length: 130



SZM200

URBAN
Lever on Round Rose
2 Part Screw-on-Rose

Dimensions (mm):

Rose: 51 Dia.
Rose Thickness: 10
Projection: 65
Lever Length: 126



(B)



SZM210

EDGE
Lever on Round Rose
2 Part Screw-on-Rose

Dimensions (mm):

Rose: 51 Dia.
Rose Thickness: 10
Projection: 62
Lever Length: 120



(B)

Serozzetta levers are supplied with bolt through fixings only and should be used in conjunction with BTL's on P197 and Eurospec locks. For matching escutcheons SZM001-3 see P147. For matching bathroom turn SZM004 see P149.

SEROZZETTA M RANGE

Levers on Rose



SZM220

CONCEPT

Lever on Round Rose
2 Part Screw-on-Rose

Dimensions (mm):

Rose:	51 Dia.
Rose Thickness:	10
Projection:	55
Lever Length:	125



CP



SC

(B)



SZM230

CITY

Lever on Round Rose
2 Part Screw-on-Rose

Dimensions (mm):

Rose:	51 Dia.
Rose Thickness:	10
Projection:	69
Lever Length:	132.5



CP



SC

(B)



SZM250

IMAGE (Dual Finish)

Lever on Round Rose
2 Part Screw-on-Rose

Dimensions (mm):

Rose:	51 Dia.
Rose Thickness:	10
Projection:	66
Lever Length:	130



CPSC

(B)

Serozzetta levers are supplied with bolt through fixings only and should be used in conjunction with BTL's on P197 and Eurospec locks. For matching escutcheons SZM001-3 see P147. For matching bathroom turn SZM004 see P149.

For matching square
escutcheons SZM001-3SQ
see P148
For matching square
bathroom turn SZM004SQ
see P149

**SZM320****CUBE**

Lever on Square Rose
Grub Screw Fixing on Rose

Dimensions (mm):

Rose: 51.5x51.5
Rose Thickness: 10
Projection: 66
Lever Length: 129.5



BN



CP



SC

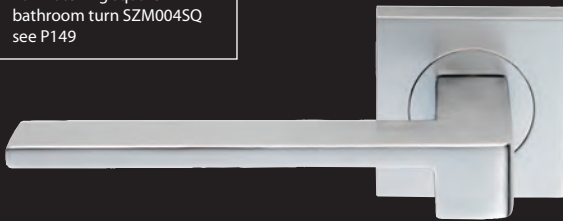

For matching square
escutcheons SZM001-3SQ
see P148
For matching square
bathroom turn SZM004SQ
see P149

**SZM370****EQUI**

Lever on Square Rose
Grub Screw Fixing on Rose

Dimensions (mm):

Rose: 51.5x51.5
Rose Thickness: 10
Projection: 47
Lever Length: 124



BN



CP



SC

**SZM380****DESIGN**

Lever on Round Rose
2 Part Screw-on-Rose

Dimensions (mm):

Rose: 51 Dia.
Rose Thickness: 10
Projection: 74
Lever Length: 116



CP



SC

Serozzetta levers are supplied with bolt through fixings only and should be used in conjunction with BTLs on P197 and Eurospec locks. For matching escutcheons SZM001-3 see P147. For matching bathroom turn SZM004 see P149.

**SZS010****ROSA**

Lever on Round Rose
2 Part Screw-on-Rose

Dimensions (mm):

Rose: 51 Dia.
Rose Thickness: 10
Projection: 68
Lever Length: 109



BN



CP



SC

B

**SZS030****VERDE**

Lever on Round Rose
2 Part Screw-on-Rose

Dimensions (mm):

Rose: 51 Dia.
Rose Thickness: 10
Projection: 69
Lever Length: 113



BN



CP



SC

B

**SZS040****ROJA**

Lever on Round Rose
2 Part Screw-on-Rose

Dimensions (mm):

Rose: 51 Dia.
Rose Thickness: 10
Projection: 67
Lever Length: 113



CP



SC

B

**SZS050****VIOLETA**

Lever on Round Rose
2 Part Screw-on-Rose

Dimensions (mm):

Rose:	51 Dia.
Rose Thickness:	10
Projection:	62
Lever Length:	109



CP



SC

**SZS060****MORADO**

Lever on Round Rose
2 Part Screw-on-Rose

Dimensions (mm):

Rose:	51 Dia.
Rose Thickness:	10
Projection:	65
Lever Length:	130



CP



SC

**SZS070****GRIS**

Lever on Round Rose
2 Part Screw-on-Rose

Dimensions (mm):

Rose:	51 Dia.
Rose Thickness:	10
Projection:	65
Lever Length:	120



CP



SC



Serozzetta levers are supplied with bolt through fixings only and should be used in conjunction with BTL's on P197 and Eurospec locks. For matching escutcheons AA1-3 see P150. For matching bathroom turns SZS004, AA10-12 and AQ11-12 see P149-152.

SEROZZETTA 2 RANGE

Levers on Rose

2

Serozzetta



SZS080

MORENO

Lever on Round Rose
2 Part Screw-on-Rose

Dimensions (mm):

Rose:	51 Dia.
Rose Thickness:	10
Projection:	65
Lever Length:	120



CP



SC

B

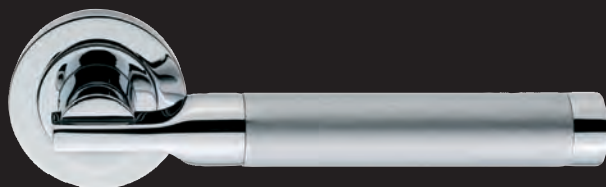

SZS110

AZUL (Dual Finish)

Lever on Round Rose
2 Part Screw-on-Rose

Dimensions (mm):

Rose:	51 Dia.
Rose Thickness:	10
Projection:	60
Lever Length:	126



SCCP



SZS120

AMARILLO

Lever on Round Rose
2 Part Screw-on-Rose

Dimensions (mm):

Rose:	51 Dia.
Rose Thickness:	10
Projection:	56
Lever Length:	114



CP



SC

Serozzetta levers are supplied with bolt through fixings only and should be used in conjunction with BTLs on P197 and Eurospec locks. For matching escutcheons AA1-3 see P150. For matching bathroom turns SZS004, AA10-12 and AQ11-12 see P149-152.

**SZS130****BLANCO**

Lever on Round Rose
2 Part Screw-on-Rose

Dimensions (mm):

Rose:	51 Dia.
Rose Thickness:	10
Projection:	57
Lever Length:	116



CP



SC

**SZS140****LIMA**

Lever on Round Rose
2 Part Screw-on-Rose

Dimensions (mm):

Rose:	51 Dia.
Rose Thickness:	10
Projection:	65
Lever Length:	125



CP

**SZS140****LIMA (Dual Finish)**

Lever on Round Rose
2 Part Screw-on-Rose

Dimensions (mm):

Rose:	51 Dia.
Rose Thickness:	10
Projection:	65
Lever Length:	125



CPSC

Serozzetta levers are supplied with bolt through fixings only and should be used in conjunction with BTL's on P197 and Eurospec locks. For matching escutcheons AA1-3 see P150. For matching bathroom turns SZS004, AA10-12 and AQ11-12 see P149-152.

SEROZZETTA 2 RANGE

Levers on Rose

**SZS160**

AMBAR (Dual Finish)
Lever on Round Rose
2 Part Screw-on-Rose

Dimensions (mm):

Rose:	51 Dia.
Rose Thickness:	10
Projection:	68
Lever Length:	130

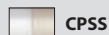
**CPSS****SZS350**

TOPO (Dual Finish)
Lever on Round Rose
2 Part Screw-on-Rose

Dimensions (mm):

Rose:	51 Dia.
Rose Thickness:	10
Projection:	66
Lever Length:	125

**CPSC****SZS360**

MARINO (Dual Finish)
Lever on Round Rose
2 Part Screw-on-Rose

Dimensions (mm):

Rose:	51 Dia.
Rose Thickness:	10
Projection:	68
Lever Length:	122.5

**CPSC**

Serozzetta levers are supplied with bolt through fixings only and should be used in conjunction with BTLs on P197 and Eurospec locks. For matching escutcheons AA1-3 see P150. For matching bathroom turns SZS004, AA10-12 and AQ11-12 see P149-152.

For matching pull handle
AA15 see P123



AQ1

STELLA

Lever on Round Rose

Dimensions (mm):

Rose:	51 Dia.
Rose Thickness:	10
Projection:	74
Lever Length:	110



CP



PB



SC



For matching pull handles
AA16A - E see P124

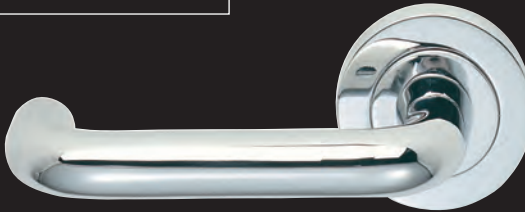

AQ2

STUDIO H

Lever on Round Rose

Dimensions (mm):

Rose:	51 Dia.
Rose Thickness:	10
Projection:	65
Lever Length:	120



CP



PB



SC

AQ3

APOLLO

Lever on Round Rose

Dimensions (mm):

Rose:	51 Dia.
Rose Thickness:	10
Projection:	64
Lever Length:	118



CP



PB



SC

Round edge roses are screw face fix only. Sharp edge roses with fixing bolts can be offered as an alternative.

All designer levers are available in mixed finishes and on backplate as special orders.

For matching escutcheons AA1-3 see P150. For matching bathroom turns AQ11-12 and AA10-12 see P151-152.



For matching pull handles
AA14A - B see P123

AQ4

CALLA

Lever on Round Rose

Dimensions (mm):

Rose:	51 Dia.
Rose Thickness:	10
Projection:	61
Lever Length:	115



CP



PB



SC

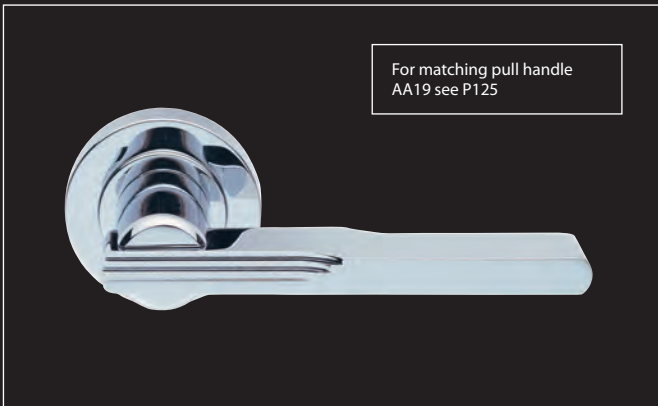

For matching pull handle
AA19 see P125

AQ5

VERONICA

Lever on Round Rose

Dimensions (mm):

Rose:	51 Dia.
Rose Thickness:	10
Projection:	61
Lever Length:	120



CP



PB



SC *SPECIAL ORDER

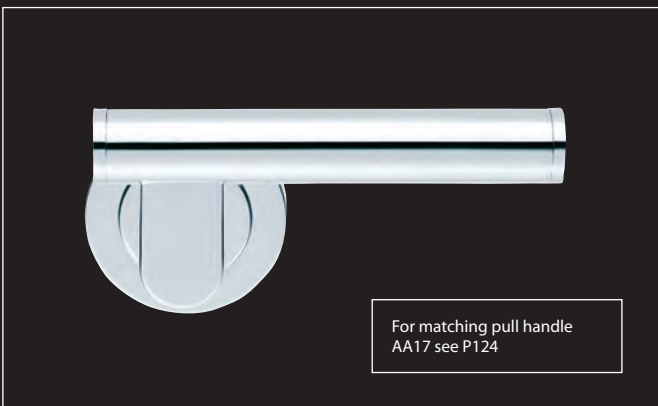

For matching pull handle
AA17 see P124

AQ6

ESPRIT

Lever on Round Rose

Dimensions (mm):

Rose:	51 Dia.
Rose Thickness:	10
Projection:	65
Lever Length:	115



CP *SPECIAL ORDER



PB



SC

Round edge roses are screw face fix only. Sharp edge roses with fixing bolts can be offered as an alternative.

All designer levers are available in mixed finishes and on backplate as special orders.

For matching escutcheons AA1-3 see P150. For matching bathroom turns AQ11-12 and AA10-12 see P151-152.

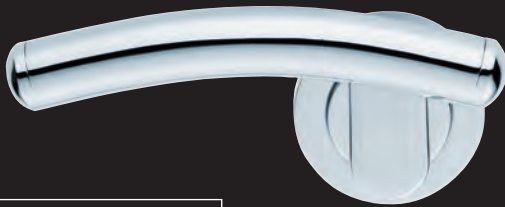

For matching pull handle
AA18 see P125

AQ7

ESPRIT 2

Lever on Round Rose

Dimensions (mm):

Rose:	51 Dia.
Rose Thickness:	10
Projection:	60
Lever Length:	130



CP



PB



SC



AQ8

SQUIGGLE

Lever on Round Rose

Dimensions (mm):

Rose:	51 Dia.
Rose Thickness:	10
Projection:	65
Lever Length:	125



CP



PB



SC



EV5

EVIA

Lever on Round Rose

Dimensions (mm):

Rose:	51 Dia.
Rose Thickness:	10
Projection:	70
Lever Length:	120



CP *SPECIAL ORDER



PB *SPECIAL ORDER



SC *SPECIAL ORDER

Round edge roses are screw face fix only. Sharp edge roses with fixing bolts can be offered as an alternative.

All designer levers are available in mixed finishes and on backplate as special orders.

For matching escutcheons AA1-3 see P150. For matching bathroom turns AQ11-12 and AA10-12 see P151-152.



PE5

PETRA

Lever on Round Rose

Dimensions (mm):

Rose: 51 Dia.
 Rose Thickness: 10
 Projection: 55
 Lever Length: 123



CP



PB



SC *SPECIAL ORDER



LM5

LE MANS

Lever on Round Rose

Dimensions (mm):

Rose: 51 Dia.
 Rose Thickness: 10
 Projection: 55
 Lever Length: 148



CP



PB *SPECIAL ORDER



SC *SPECIAL ORDER



G15

GIAVA

Lever on Round Rose

Dimensions (mm):

Rose: 51 Dia.
 Rose Thickness: 10
 Projection: 60
 Lever Length: 131



CP



PB



SC

Round edge roses are screw face fix only. Sharp edge roses with fixing bolts can be offered as an alternative.

All designer levers are available in mixed finishes and on backplate as special orders.

For matching escutcheons AA1-3 see P150. For matching bathroom turns AQ11-12 and AA10-12 see P151-152.

**SA5****SALINA**

Lever on Round Rose

Dimensions (mm):

Rose:	51 Dia.
Rose Thickness:	10
Projection:	76
Lever Length:	127

**CP****PB****SB *SPECIAL ORDER****SC *SPECIAL ORDER****NI5****NIRVANA**

Lever on Round Rose

Dimensions (mm):

Rose:	51 Dia.
Rose Thickness:	10
Projection:	63
Lever Length:	129

**CP****PB *SPECIAL ORDER****SC****DA5****DALI**

Lever on Round Rose

Dimensions (mm):

Rose:	51 Dia.
Rose Thickness:	10
Projection:	65
Lever Length:	123

**CP****PB *SPECIAL ORDER****SB *SPECIAL ORDER****SC**

Round edge roses are screw face fix only. Sharp edge roses with fixing bolts can be offered as an alternative.

All designer levers are available in mixed finishes and on backplate as special orders.

For matching escutcheons AA1-3 see P150. For matching bathroom turns AQ11-12 and AA10-12 see P151-152.

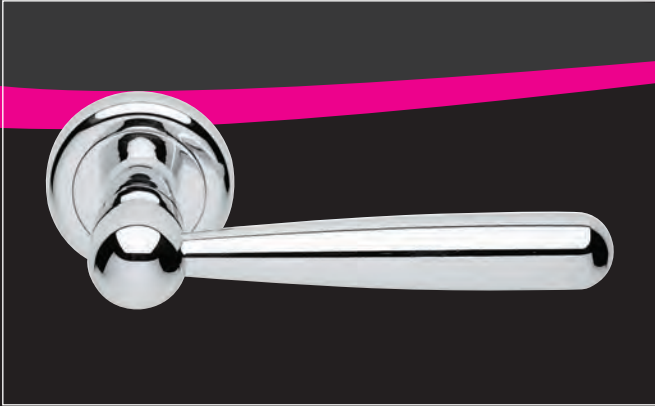

BO5

BOHEME

Lever on Round Rose

Dimensions (mm):

Rose:	51 Dia.
Rose Thickness:	10
Projection:	66
Lever Length:	134



CP



PB *SPECIAL ORDER



SN *SPECIAL ORDER



BR5

BRESCIA

Lever on Round Rose

Dimensions (mm):

Rose:	52 Dia.
Rose Thickness:	10
Projection:	63
Lever Length:	125



CP *SPECIAL ORDER



PB *SPECIAL ORDER



EL5

ELIS

Lever on Round Rose

Dimensions (mm):

Rose:	51 Dia.
Rose Thickness:	10
Projection:	62
Lever Length:	144



CP *SPECIAL ORDER



PB *SPECIAL ORDER



SC

Round edge roses are screw face fix only. Sharp edge roses with fixing bolts can be offered as an alternative.

All designer levers are available in mixed finishes and on backplate as special orders.

For matching escutcheons AA1-3 see P150. For matching bathroom turns AQ11-12 and AA10-12 see P151-152.

For matching escutcheons
and bathroom turns contact
our sales office

**MP5****MORPHOS**

Lever on Square Rose

Dimensions (mm):

Rose:	52x52
Rose Thickness:	10
Projection:	65
Lever Length:	127

 **CP *SPECIAL ORDER**
 **SC *SPECIAL ORDER**
 **SCCP *SPECIAL ORDER**

For matching escutcheons
and bathroom turns contact
our sales office

**PX5****PRESO**

Lever on Square Rose

Dimensions (mm):

Rose:	52x52
Rose Thickness:	10
Projection:	61
Lever Length:	133

 **CP *SPECIAL ORDER**
 **PB *SPECIAL ORDER**
 **SC *SPECIAL ORDER**
WD5**WIND**

Lever on Round Rose

Dimensions (mm):

Rose:	51 Dia.
Rose Thickness:	10
Projection:	66
Lever Length:	128

 **CP**
 **PB**
 **SC**

Round edge roses are screw face fix only. Sharp edge roses with fixing bolts can be offered as an alternative.

All designer levers are available in mixed finishes and on backplate as special orders.

WD5 For matching escutcheons AA1-3 see P150. For matching bathroom turns AQ11-12 and AA10-12 see P151-152.

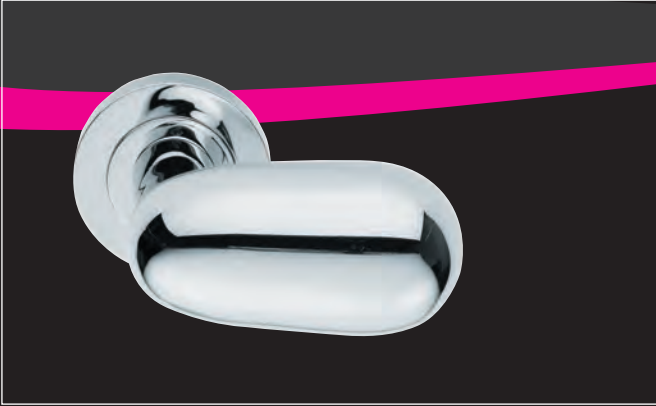

U05

UOVO

Lever on Round Rose

Dimensions (mm):

Rose: 51 Dia.
Rose Thickness: 10
Projection: 79
Lever Length: 78



CP



PB



SC *SPECIAL ORDER



DISCPBL

DIVA

Lever on Round Rose

Dimensions (mm):

Rose: 51 Dia.
Rose Thickness: 10
Projection: 63
Lever Length: 125



CP *SPECIAL ORDER



PB *SPECIAL ORDER



SC *SPECIAL ORDER



AT5

ATENA

Lever on Round Rose

Dimensions (mm):

Rose: 51 Dia.
Rose Thickness: 10
Projection: 69
Lever Length: 130



CP *SPECIAL ORDER



PB *SPECIAL ORDER



SC *SPECIAL ORDER



SNPN *SPECIAL ORDER

Round edge roses are screw face fix only. Sharp edge roses with fixing bolts can be offered as an alternative.

All designer levers are available in mixed finishes and on backplate as special orders.

For matching escutcheons AA1-3 see P150. For matching bathroom turns AQ11-12 and AA10-12 see P151-152.

**EA5****EASY**

Lever on Round Rose

Dimensions (mm):

Rose:	51 Dia.
Rose Thickness:	10
Projection:	60
Lever Length:	140

**CP *SPECIAL ORDER****PB *SPECIAL ORDER****SC *SPECIAL ORDER****SU5****SURF**

Lever on Round Rose

Dimensions (mm):

Rose:	51 Dia.
Rose Thickness:	10
Projection:	50
Lever Length:	150

**CP *SPECIAL ORDER****PB *SPECIAL ORDER****SC *SPECIAL ORDER****BD5****BLADE**

Lever on Round Rose

Dimensions (mm):

Rose:	51 Dia.
Rose Thickness:	10
Projection:	73
Lever Length:	128

**CP *SPECIAL ORDER****SC *SPECIAL ORDER**

Round edge roses are screw face fix only. Sharp edge roses with fixing bolts can be offered as an alternative.

All designer levers are available in mixed finishes and on backplate as special orders.

For matching escutcheons AA1-3 see P150. For matching bathroom turns AQ11-12 and AA10-12 see P151-152.



DU5

DUNE

Lever on Round Rose

Dimensions (mm):

Rose: 52 Dia.
Rose Thickness: 10
Projection: 71
Lever Length: 132



CP *SPECIAL ORDER



PB *SPECIAL ORDER



SB *SPECIAL ORDER



SC *SPECIAL ORDER



FR5

FRANCY

Lever on Round Rose

Dimensions (mm):

Rose: 52 Dia.
Rose Thickness: 10
Projection: 67
Lever Length: 121



CP *SPECIAL ORDER



PB *SPECIAL ORDER



SB *SPECIAL ORDER



SC *SPECIAL ORDER



TO5

TOSCA

Lever on Round Rose

Dimensions (mm):

Rose: 52 Dia.
Rose Thickness: 10
Projection: 66
Lever Length: 130



CP *SPECIAL ORDER



PB *SPECIAL ORDER



SB *SPECIAL ORDER



SC *SPECIAL ORDER

Round edge roses are screw face fix only. Sharp edge roses with fixing bolts can be offered as an alternative.

All designer levers are available in mixed finishes and on backplate as special orders.

For matching escutcheons AA1-3 see P150. For matching bathroom turns AQ11-12 and AA10-12 see P151-152.

Available with cherry wood
insert QU5C
Available with walnut wood
insert QU5W

**QU5B**

QUADRA Beech Wood Insert
Lever on Round Rose

Dimensions (mm):

Rose:	51 Dia.
Rose Thickness:	10
Projection:	70
Lever Length:	139

 **CP** *SPECIAL ORDER

 **PB** *SPECIAL ORDER

 **SB** *SPECIAL ORDER

 **SC** *SPECIAL ORDER

Various stripe colour options
available contact our sales
office

**CN5****CARMEN**

Lever on Round Rose

Dimensions (mm):

Rose:	50 Dia.
Rose Thickness:	10
Projection:	77
Lever Length:	131

 **CP** *SPECIAL ORDER

 **SC** *SPECIAL ORDER

 **SN** *SPECIAL ORDER

**SP5****SPOON**

Lever on Round Rose

Dimensions (mm):

Rose:	52 Dia.
Rose Thickness:	12
Projection:	65
Lever Length:	145

 **CP** *SPECIAL ORDER

 **PB** *SPECIAL ORDER

 **SB** *SPECIAL ORDER

 **SC** *SPECIAL ORDER

 **SN** *SPECIAL ORDER

Round edge roses are screw face fix only. Sharp edge roses with fixing bolts can be offered as an alternative.

All designer levers are available in mixed finishes and on backplate as special orders.

For matching escutcheons AA1-3 see P150. For matching bathroom turns AQ11-12 and AA10-12 see P151-152.

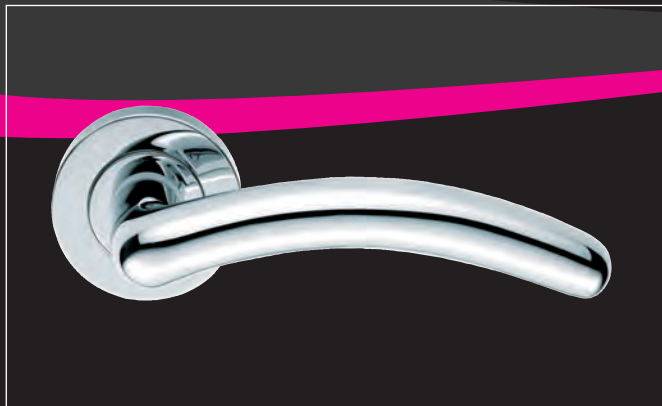

003

NOXIA

Lever on Round Rose

Dimensions (mm):

Rose: 51 Dia.

Rose Thickness: 10



CP



PB *SPECIAL ORDER



SC



004

TROY

Lever on Round Rose

Dimensions (mm):

Rose: 51 Dia.

Rose Thickness: 10



PB/SB



PC/SC

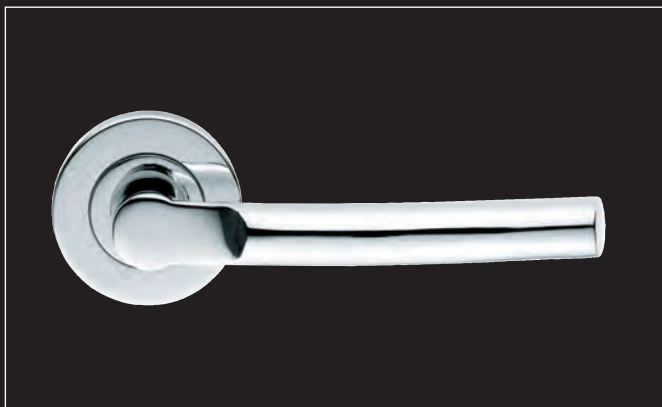

111

NELSON

Lever on Round Rose

Dimensions (mm):

Rose: 51 Dia.

Rose Thickness: 10



CP



PB *SPECIAL ORDER



SC



112

OLIVIER

Lever on Round Rose

Dimensions (mm):

Rose: 51 Dia.
Rose Thickness: 10



CP



PB *SPECIAL ORDER



SC



113

TEMPEST

Lever on Round Rose

Dimensions (mm):

Rose: 51 Dia.
Rose Thickness: 10



CP



PB *SPECIAL ORDER



SC

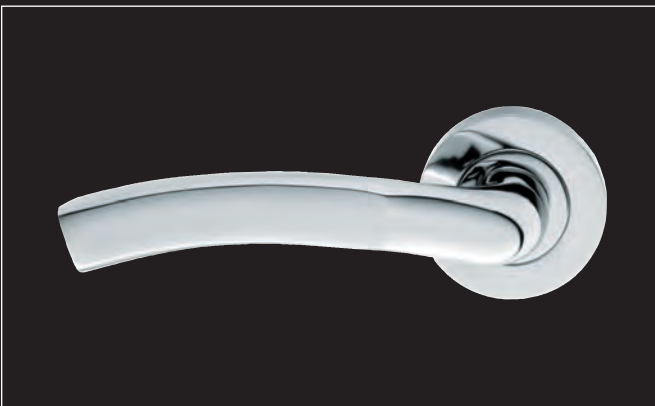

114

TITAN

Lever on Round Rose

Dimensions (mm):

Rose: 51 Dia.
Rose Thickness: 10



CP



PB *SPECIAL ORDER



SC

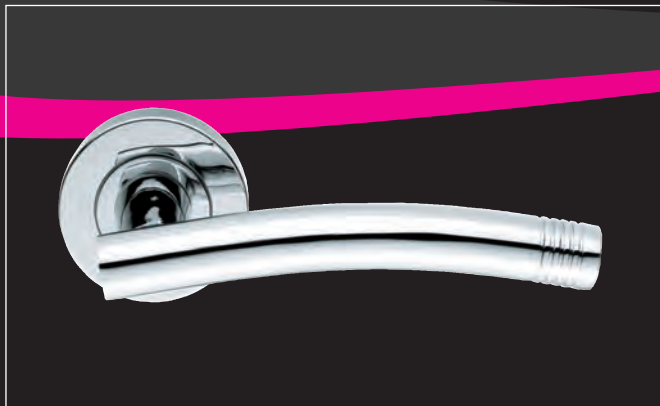

115

CAROLINA

Lever on Round Rose

(B)

Dimensions (mm):

Rose: 51 Dia.
Rose Thickness: 10



CP



PB *SPECIAL ORDER



SC

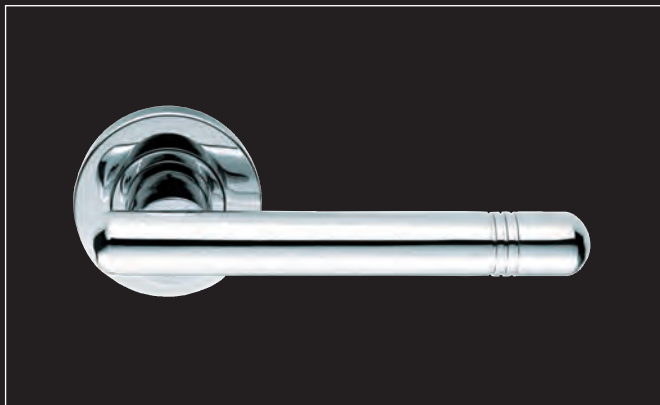

116

ATALAYA

Lever on Round Rose

Dimensions (mm):

Rose: 51 Dia.
Rose Thickness: 10



CP



PB *SPECIAL ORDER



SC



117

CLASSIC

Lever on Round Rose

Dimensions (mm):

Rose: 51 Dia.
Rose Thickness: 10



CP



PB *SPECIAL ORDER



SC

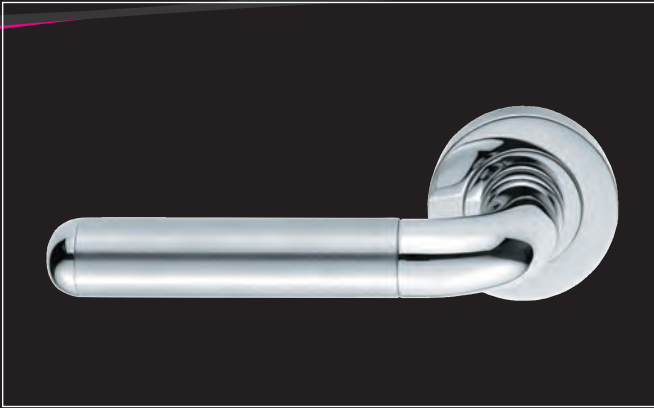

118

SHORE

Lever on Round Rose

**Dimensions (mm):**

Rose: 51 Dia.

Rose Thickness: 10



CP *SPECIAL ORDER



PB/SB



PB *SPECIAL ORDER



PC/SC



SC *SPECIAL ORDER



121

PHILADELPHIA

Lever on Round Rose

**Dimensions (mm):**

Rose: 51 Dia.

Rose Thickness: 10



CP



PB *SPECIAL ORDER



SC



123

MARINA

Lever on Round Rose

Dimensions (mm):

Rose: 51 Dia.

Rose Thickness: 10



CP



PB *SPECIAL ORDER



SC

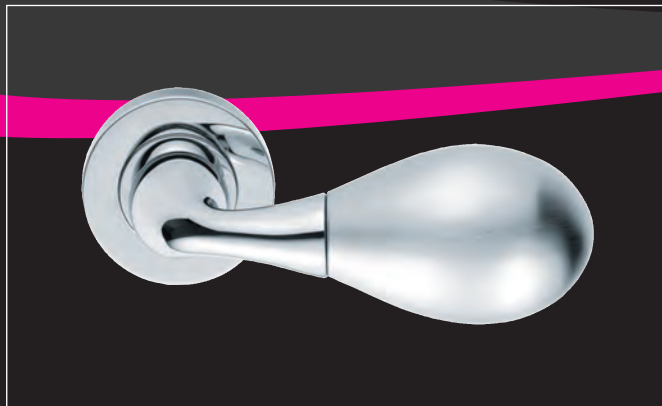

124

PEARL

Lever on Round Rose



Dimensions (mm):

Rose: 51 Dia.

Rose Thickness: 10



CP *SPECIAL ORDER



PB/SB



PB *SPECIAL ORDER



PC/SC



SC *SPECIAL ORDER



126

LOIS

Lever on Round Rose

Dimensions (mm):

Rose: 51 Dia.

Rose Thickness: 10



CP



PB *SPECIAL ORDER



SC

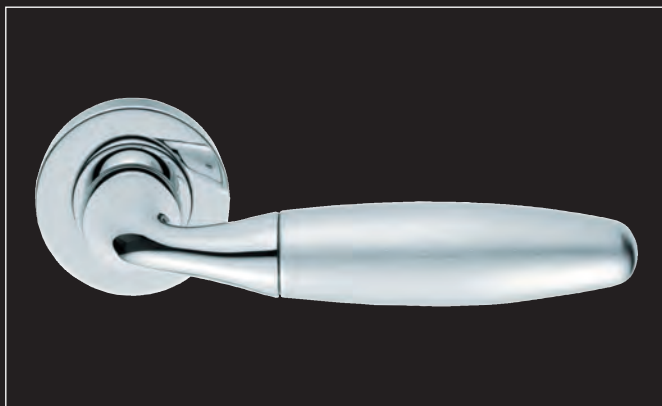

127

VENICE

Lever on Round Rose

Dimensions (mm):

Rose: 51 Dia.

Rose Thickness: 10



CP *SPECIAL ORDER



PB/SB



PB *SPECIAL ORDER



PC/SC



SC *SPECIAL ORDER



129

CUMULUS

Lever on Round Rose

B

Dimensions (mm):

Rose: 51 Dia.

Rose Thickness: 10



CP *SPECIAL ORDER



PB/SB



PB *SPECIAL ORDER



PC/SC



SC *SPECIAL ORDER



130

VERDUN

Lever on Round Rose

B

Dimensions (mm):

Rose: 51 Dia.

Rose Thickness: 10



CP



PB *SPECIAL ORDER



SC



134

ARCADIA

Lever on Round Rose

Dimensions (mm):

Rose: 51 Dia.

Rose Thickness: 10



CP



PB *SPECIAL ORDER



SC



137

XERO

Lever on Round Rose

Dimensions (mm):

Rose: 51 Dia.
Rose Thickness: 10

 PC/SC



138

MAISON

Lever on Round Rose

Dimensions (mm):

Rose: 51 Dia.
Rose Thickness: 10

 PC/SC

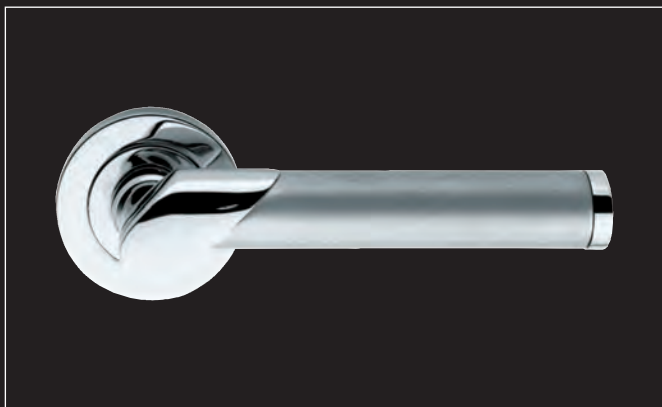

139

IRWIN

Lever on Round Rose

B

Dimensions (mm):

Rose: 51 Dia.
Rose Thickness: 10

 PC/SC



140

MARRISSA

Lever on Round Rose

Dimensions (mm):

Rose: 51 Dia.

Rose Thickness: 10



CP



PB *SPECIAL ORDER



SC



144

MANON

Lever on Round Rose

Dimensions (mm):

Rose: 51 Dia.

Rose Thickness: 10



CP



PB *SPECIAL ORDER



SC



190

SAFETY LEVER

19mm Dia. Tubular Brass

Dimensions (mm):

Rose: 51 Dia.

Rose Thickness: 10



CP



PB



SC





DL32

VICTORIAN Ascot
Heavy Lever on Round Rose

Dimensions (mm):

Rose: 58 Dia.
Rose Thickness: 10
Projection: 58
Lever Length: 101



CP



PB



SC



DL77

VICTORIAN Contemporary
Lever on Round Rose

Dimensions (mm):

Rose: 58 Dia.
Rose Thickness: 10
Projection: 57
Lever Length: 107



CP



PB



SC



DL66

WING
Lever on Round Rose

Dimensions (mm):

Rose: 58 Dia.
Rose Thickness: 10
Projection: 55
Lever Length: 115



CP



PB



SC





DL56

VICTORIAN Scroll
Lever on Round Rose

Dimensions (mm):

Rose:	58 Dia.
Rose Thickness:	10
Projection:	54
Lever Length:	98



CP



PB



SC



M32

VICTORIAN
Lever on Round Rose

Dimensions (mm):

Rose:	58 Dia.
Rose Thickness:	10
Projection:	46
Lever Length:	100



CP



PB



SC



M65

VICTORIAN M Series
Lever on Round Rose

Dimensions (mm):

Rose:	58 Dia.
Rose Thickness:	10
Projection:	49
Lever Length:	103



CP



PB



SC





For matching escutcheon
FG21 see P179
For matching bathroom turn
FG20 see P179

FG3

GEORGIAN

Lever on Round Rose

Dimensions (mm):

Rose:	64 Dia.
Rose Thickness:	11
Projection:	62
Lever Length:	102



For matching escutcheon
DL100B see P163
For matching bathroom turn
DL133B see P163

DL3

REGENCY

Lever on Round Rose

Dimensions (mm):

Rose:	62 Dia.
Rose Thickness:	9
Projection:	58
Lever Length:	103





PLG

PORCELAIN

Lever on Round Rose
Plain White and Gold on PB

Dimensions (mm):

Rose: 57 Dia.
Rose Thickness: 10
Projection: 65
Lever Length: 130



PLW

PORCELAIN

Lever on Round Rose
Plain White on PB

Dimensions (mm):

Rose: 57 Dia.
Rose Thickness: 10
Projection: 65
Lever Length: 130

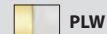

PLWCP

PORCELAIN

Lever on Round Rose

Dimensions (mm):

Rose: 57 Dia.
Rose Thickness: 10
Projection: 65
Lever Length: 130



SEROZZETTA RANGE

Levers on Backplate



SZC011Y

UNO Lock Euro
47.5 c/c

Dimensions (mm):

Backplate:	170x42
Lever Length:	109
Projection:	68
Plate Thickness:	10

Variations:

SZC011	Lock
SZC012	Latch
SZC013	Bathroom



CP



SC



SZC023

DOS Bathroom

Dimensions (mm):

Backplate:	170x42
Lever Length:	113
Projection:	69
Plate Thickness:	10

Variations:

SZC021	Lock
SZC021Y	Euro 47.5c/c
SZC022	Latch



CP



SC

**SZC031****TRES** Lock**Dimensions (mm):**

Backplate:	170x42
Lever Length:	113
Projection:	69
Plate Thickness:	10

Variations:

SZC031Y	Lock Euro 47.5c/c
SZC032	Latch
SZC033	Bathroom



CP



SC

B

**SZC042****CUATRO** Latch**Dimensions (mm):**

Backplate:	170x42
Lever Length:	113
Projection:	67
Plate Thickness:	10

Variations:

SZC041	Lock
SZC041Y	Euro 47.5c/c
SZC043	Bathroom



CP



SC

B

SEROZZETTA RANGE

Levers on Backplate



SZC053

CINCO Bathroom

Dimensions (mm):

Backplate:	170x42
Lever Length:	109
Projection:	62
Plate Thickness:	10

Variations:

SZC051	Lock
SZC051Y	Lock Euro 47.5 c/c
SZC052	Latch



CP

SC

**SZM067****SYSTEM** Latch**Dimensions (mm):**

Backplate:	180x40
Lever Length:	114
Projection:	62
Plate Thickness:	10

Variations:

SZM066	Lock
SZM066Y	Lock Euro 47.5 c/c
SZM068	Bathroom



CP

**SZM371****EQUI** Lock**Dimensions (mm):**

Backplate:	180x40
Lever Length:	124
Projection:	65
Plate Thickness:	10

Variations:

SZM372	Latch
SZM371Y	Lock Euro 47.5c/c
SZM373	Bathroom



CP



SC

SEROZZETTA M RANGE

Levers on Backplate



SZM035

ZONE Latch

Dimensions (mm):

Backplate:	180x40
Lever Length:	120
Projection:	66
Plate Thickness:	10

Variations:

SZM034	Lock
SZM034Y	Lock Euro 47.5 c/c
SZM036	Bathroom



SZM243

STRATUS Bathroom

Dimensions (mm):

Backplate:	180x40
Lever Length:	129
Projection:	69
Plate Thickness:	10

Variations:

SZM242	Latch
SZM241	Lock
SZM241Y	Lock Euro 47.5c/c



**SZM045****SCOPE** Latch**Dimensions (mm):**

Backplate:	180x40
Lever Length:	129
Projection:	63
Plate Thickness:	10

Variations:

SZM044	Lock
SZM046	Bathroom

Finish:

SZM044Y	Lock Euro 47.5 c/c	CP
----------------	--------------------	-----------



CP



CPSN

**SZM056****SHAPE** Latch**Dimensions (mm):**

Backplate:	180x40
Lever Length:	114
Projection:	61
Plate Thickness:	10

Variations:

SZM055	Lock
SZM055Y	Lock Euro 47.5c/c
SZM057	Bathroom



CP



DL345

WENTWORTH Latch
Long Backplate

Dimensions (mm):

Backplate:	270x48
Lever Length:	108
Projection:	60
Plate Thickness:	10

Variations:

DL344	Lock
DL346	Bathroom



FB



PB



DL341

WENTWORTH Latch
Short Backplate

Dimensions (mm):

Backplate:	180x48
Lever Length:	108
Projection:	60
Plate Thickness:	10

Variations:

DL340	Lock
DL342	Bathroom



FB



PB



For matching letterplate DL347 see P100.



Also available with Short
Backplate 180x48mm

DL355**ST GEORGE** Latch
Long Backplate**Dimensions (mm):**

Backplate:	270x48
Lever Length:	110
Projection:	66
Plate Thickness:	10

Variations:

DL354	Lock
DL356	Bathroom

Short Plate Variations:

Short Backplate	180x48
DL351	Latch
DL350	Lock
DL352	Bathroom



PB



Also available with Long
Backplate 268x48mm
For matching letterplate
DL348FB see P100

DL451**LYTHAM** Latch
Short Backplate**Dimensions (mm):**

Backplate:	180x48
Lever Length:	122
Projection:	63
Plate Thickness:	10

Variations:

DL450	Lock
DL452	Bathroom

Long Plate Variations:

Long Backplate	268x48
----------------	--------

Finishes: **SBPB/SCCP**

DL454	Lock
DL455	Latch
DL456	Bathroom



SBPB



SCCP



FB



B



DL279

VERSAILLES Latch

Dimensions (mm):

Backplate:	270x48
Lever Length:	110
Projection:	66
Plate Thickness:	9

Variations:

DL278	Lock
DL277	Bathroom



PB



DL411

EDEN Latch

Dimensions (mm):

Backplate:	180x40
Lever Length:	108
Projection:	67
Plate Thickness:	11

Variations:

DL410	Lock
DL412	Bathroom

Also available in Stainless Brass (PVD) with 25 year guarantee



CP



PB



PVD



SC



**DL280**

SEVILLE Lock
Long Backplate

Dimensions (mm):

Backplate:	240x44
Lever Length:	110
Projection:	55.5
Plate Thickness:	8

Variations:

DL281	Latch
DL282	Bathroom



PB

**DL171**

SEVILLE Latch
Short Backplate

Dimensions (mm):

Backplate:	180x44
Lever Length:	110
Projection:	55.5
Plate Thickness:	8

Variations:

DL170	Lock
DL170Y	Lock Euro 47.5c/c
DL172	Bathroom



FB



PB



IR1

IRIS Latch

Round Bar Lever on Backplate

Dimensions (mm):

Backplate:	245x42
Lever Length:	117.5
Projection:	60
Plate Thickness:	10

Variations:

IR2	Lock
IR2Y	Lock Euro 47.5c/c
IR3	Bathroom



CP *SPECIAL ORDER



PB



SC *SPECIAL ORDER



EL12

IBRA Latch

Dimensions (mm):

Backplate:	185x42
Lever Length:	116
Projection:	66
Plate Thickness:	10

Variations:

EL11	Lock
EL11U	Lock Oval 48.5c/c
EL11Y	Lock Euro 47.5c/c
EL13	Bathroom



CP



PB



SC

For matching letterplate
M304 see P101

B



For matching letterplate
M304 see P101

DL286

BONA Latch
Sterling Collection

Dimensions (mm):

Backplate:	224x46
Lever Length:	115
Projection:	66.5
Plate Thickness:	8.5

Variations:

DL285	Lock
DL287	Bathroom

**PB**



For euro profile
availability contact our
sales office

EL22

ASTRO Latch
Euroline Collection

Dimensions (mm):

Backplate:	185x42
Lever Length:	109
Projection:	66
Plate Thickness:	10

Variations:

EL21	Lock
EL23	Bathroom
EL21Y	Lock Euro 47.5c/c
EL21U	Lock Oval 48.5c/c

***SPECIAL ORDER**



CP



PB



SC ***SPECIAL ORDER**



EL32

LILLA Latch
Euroline Collection

Dimensions (mm):

Backplate:	185x42
Lever Length:	116
Projection:	59
Plate Thickness:	10

Variations:

EL31	Lock
EL31U	Lock Oval 48.5c/c
EL31Y	Lock Euro 47.5c/c
EL33	Bathroom



CP



PB



SC



For matching letterplate M304 see P101.



For matching letterplate
M304 see P101
For euro profile
availability contact our
sales office

EL42

IRIS Latch
Euroline Collection

Dimensions (mm):

Backplate:	185x42
Lever Length:	117
Projection:	59
Plate Thickness:	10

Variations:

EL41	Lock
EL43	Bathroom
EL41Y	Lock Euro 47.5c/c
EL41U	Lock Oval 48.5c/c

***SPECIAL ORDER**



CP



PB

SC ***SPECIAL ORDER****EL60**

WING Lock
Euroline Collection

Dimensions (mm):

Backplate:	185x42
Lever Length:	114
Projection:	56
Plate Thickness:	10

Variations:

EL61	Latch
EL62	Bathroom

Finishes: CP/PB

EL60Y Lock Euro 47.5c/c



CP



PB



SC





DL291

MADRID Latch
Sterling Collection
Long Backplate

Dimensions (mm):

Backplate: 242x45
Lever Length: 112
Projection: 55
Plate Thickness: 10

Variations:

DL290 Lock
DL292 Bathroom

Finish: PB
DL290Y85 Lock Euro 85c/c

Finishes: CP/PVD
DL290Y Lock Euro 47.5c/c



DL191

MADRID Latch
Sterling Collection
Short Backplate

Dimensions (mm):

Backplate: 180x45
Lever Length: 112
Projection: 55
Plate Thickness: 10

Variations:

DL190 Lock
DL192 Bathroom





DL380U - CP and SC only
available as special finishes

DL381

ANDROS Latch
Sterling Collection
Long Backplate

Dimensions (mm):

Backplate:	240x40
Lever Length:	115
Projection:	58
Plate Thickness:	10

Variations:

DL380	Lock
DL382	Bathroom
DL380Y	Lock Euro 47.5c/c

Finishes: **CP/SC**
DL380U* Lock Oval 48.5c/c

*SPECIAL ORDER

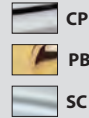
**DL181**

ANDROS Latch
Sterling Collection
Short Backplate

Dimensions (mm):

Backplate:	180x40
Lever Length:	115
Projection:	58
Plate Thickness:	10

Variations:

DL180	Lock
DL182	Bathroom

Finishes: **CP/SC**
DL180Y Lock Euro 47.5c/c

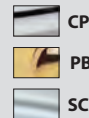

(B)



Also available with Short Backplate 112x42mm

DL167

OAKLEY Latch

Dimensions (mm):

Backplate:	170x42
Lever Length:	97
Projection:	54
Plate Thickness:	10

Variations:

DL168	Lock
DL168WC	Bathroom
DL168U	Lock Oval 48.5c/c
DL168Y	Lock Euro 47.5c/c

Finishes:	CP/PB/SC
DL167WC	Privacy

Short Plate Variations:

Short Backplate	112x42
-----------------	--------

Finishes:	CP/PB
DL166	Latch



CP



PVD



PB



SC



DL301

GARRICK Lock

Dimensions (mm):

Backplate:	175x50
Lever Length:	97
Projection:	53
Plate Thickness:	10

Variations:

DL300	Latch
DL302	Bathroom



PB





Also available with Short
Backplate 112x48mm
For matching letterplate
DL19 see P100
For matching fingerplate
DL20 see P174

DL17

ASHTEAD Latch

Dimensions (mm):

Backplate:	168x48
Lever Length:	97
Projection:	58
Plate Thickness:	13

Variations:

DL18 Latch

DL18WC Bathroom

Finishes: CP/PB

DL17Y Lock Euro 47.5c/c

Finish: PB

DL17U Lock Oval 48.5c/c

Short Plate Variations:

Short Backplate 112x48

Finishes: CP/PB

DL16 Latch



CP



PB

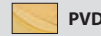

PVD



DL68

BIRKDALE Lock

Dimensions (mm):

Backplate:	170x45
Lever Length:	97
Projection:	55
Plate Thickness:	10

Variations:

DL67 Latch

DL68WC Bathroom

DL68U Lock Oval 48.5c/c



CP



PB

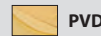

PVD





Also available with Short Backplate 118x43mm
Also available on rose DL32 see P40
For matching letterplates see P100-101

DL30

VICTORIAN ASCOT Lock

Heavy

Dimensions (mm):

Backplate:	150x43
Lever Length:	102.5
Projection:	52
Plate Thickness:	10

Variations:

DL30WC	Bathroom
DL30Y	Lock Euro 47.5c/c

Finish:	PB
DL30U	Lock Oval 48.5c/c

Short Plate Variations:

Short Backplate	118x43
-----------------	--------

Finishes:	CP/PB/SC
DL31	Latch
DL31WC	Privacy

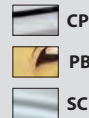

Also available with Short Backplate 118x43mm
Also available on rose M65 see P41
M63U - CP available as a special finish

M63

VICTORIAN M SERIES Lock

Dimensions (mm):

Backplate:	150x43
Lever Length:	103
Projection:	60
Plate Thickness:	10

Variations:

M63Y	Lock Euro 47.5c/c
M63WC	Bathroom

Finish:	PB
M63U	Lock Oval 48.5c/c

Short Plate Variations:

Short Backplate	118x43
-----------------	--------

Finishes:	CP/PB/SC
M64	Latch

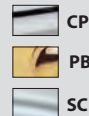



Also available with Short Backplate 118x43mm
Also available on rose DL77 see P40
For matching letterplates see P100-101
DL75U - CP and PB only available as special finishes

DL75

VICTORIAN CONTEMPORARY Lock

Dimensions (mm):

Backplate: 150x43
Lever Length: 107.5
Projection: 58
Plate Thickness: 10

Variations:

DL75WC Bathroom
DL75Y Lock Euro 47.5c/c

Finishes: **CP/PB**

DL75U* Lock Oval 48.5c/c

*SPECIAL ORDER

Short Plate Variations:

Short Backplate 118x43

Finishes: **CP/PB/SC**

DL76 Latch

DL76WC Privacy



CP



PB



SC



Also available with Short Backplate 118x43mm
Contract range available contact our sales office

M30

VICTORIAN Lock

Dimensions (mm):

Backplate: 150x43
Lever Length: 103
Projection: 44
Plate Thickness: 10

Variations:

M30U Lock Oval 48.5c/c

M30Y Lock Euro 47.5c/c

M30WC Bathroom

Short Plate Variations:

Short Backplate 118x43

Finishes: **CP/PB/SC**

M31 Latch

M31WC Privacy



CP



PB



SC





Also available with Short
Backplate 115x42mm

DL64

WING Lock

Dimensions (mm):

Backplate:	150x42
Lever Length:	110
Projection:	60
Plate Thickness:	10

Variations:

DL64WC	Bathroom
DL64Y	Lock Euro 47.5 c/c

Short Plate Variations:

Short Backplate	115x42
DL65	Latch
DL65WC	Privacy

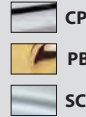

DL54

VICTORIAN SCROLL Lock

Dimensions (mm):

Backplate:	150x43
Lever Length:	98
Projection:	55
Plate Thickness:	10

Variations:

DL54WC	Bathroom
DL54Y	Lock Euro 47.5c/c
DL54U	Lock Oval 48.5c/c

Short Plate Variations:

Short Backplate	118x43
-----------------	--------

Finishes:

DL55	CP/PB/SC Latch
DL55WC	Privacy

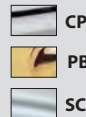

B



Also available with Short
Backplate 118x43mm
Also available on rose
DL56 see P41
Contract range available
contact our sales office



Also available with Short
Backplate 172x40mm

DL461

SAVANNAH Latch

Dimensions (mm):

Backplate:	238x35
Lever Length:	94
Projection:	54
Plate Thickness:	10

Variations:

DL460	Lock
DL462	Bathroom

Short Plate Variations:

Short Backplate	172x40
-----------------	--------

Finishes:

DL160	Lock	CP/SC
DL161	Latch	
DL162	Bathroom	
DL160Y	Lock Euro 47.5c/c	



M68

**VICTORIAN SHAPED
SCROLL Lock**

Dimensions (mm):

Backplate:	204x48
Lever Length:	97
Projection:	53
Plate Thickness:	8

Variations:

M68WC	Bathroom
M67	Latch
M68Y	Lock Euro 47.5c/c

Finish:

M68U	Lock Oval 48.5c/c	PB
-------------	-------------------	-----------



Contract range available
contact our sales office



Also available with Short
Backplate 172x50mm

DL271

CHESHAM Lock

Dimensions (mm):

Backplate:	248x50
Lever Length:	108
Projection:	40
Plate Thickness:	6.8

Variations:

DL270	Latch
DL272	Bathroom
DL271Y	Euro

Short Plate Variations:

Short Backplate	172x50
DL265	Latch
DL266	Lock
DL266Y	Lock Euro 47.5c/c
DL266U	Lock Oval 48.5c/c
DL267	Bathroom

Mini Variations:

Mini Backplate	110x50
DL263	Latch



PB



DL27

SHAPED REGENCY Lock

Dimensions (mm):

Backplate:	172x45
Lever Length:	102
Projection:	56
Plate Thickness:	10

Variations:

DL26	Latch
DL27WC	Bathroom



PB



Also available with Short
Backplate 170x48mm

MS10

GEORGIAN SHELBOURNE

Latch

Dimensions (mm):

Backplate:	248x48
Lever Length:	101.5
Projection:	62
Plate Thickness:	10

Variations:

MS9	Lock
MS11	Bathroom

Short Plate Variations:

Short Backplate	170x48
MS5	Lock
MS6	Latch
MS7	Bathroom



PB



Also available with Short
Backplate 110x51mm
For matching letterplate
DL107B see P112

DL100

ST JAMES Lock

Dimensions (mm):

Backplate:	155x51
Lever Length:	103.5
Projection:	60
Plate Thickness:	10.5

Variations:

DL102	Latch
DL100WC	Bathroom

Short Plate Variations:

Short Backplate	110x51
DL101	Latch



PB



FG27

GEORGIAN SHAPED Lock

Dimensions (mm):

Backplate:	204x48
Lever Length:	105.5
Projection:	60
Plate Thickness:	8

Variations:

FG27U	Lock Oval 48.5c/c
FG27Y	Lock Euro 47.5c/c
FG27WC	Bathroom
FG26L	Latch



Also available with short
backplate 112x48mm

FG1

GEORGIAN Lock

Dimensions (mm):

Backplate:	150x48
Lever Length:	101.5
Projection:	62
Plate Thickness:	10

Variations:

FG1U	Lock Oval 48.5c/c
FG1Y	Lock Euro 47.5c/c
FG1WC	Bathroom

Short Plate Variations:

Short Backplate	112x48
FG2	Latch
FG2WC	Privacy



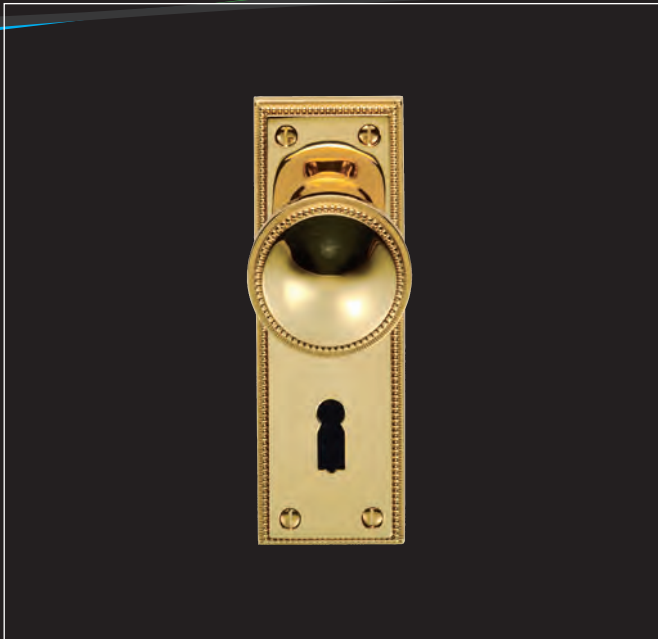

DL273B

DELAMAIN BEADED Knob
on Rectangular Backplate
Lock

Dimensions (mm):

Backplate: 152x51
Knob: 51 Dia.
Projection: 68
Plate Thickness: 10

Variations:

DL274B Latch
DL275B Bathroom



DL274SP

DELAMAIN SAUSAGE & PEA Knob
on Rectangular Backplate
Latch

Dimensions (mm):

Backplate: 152x51
Knob: 51 Dia.
Projection: 68
Plate Thickness: 10

Variations:

DL273SP Lock
DL275SP Bathroom





DELAMAIN RANGE

Knobs on Backplate



DL257B

DELAMAIN BEADED Knob
on Long Backplate
Bathroom

Dimensions (mm):

Backplate: 248x50

Knob: 51 Dia.

Projection: 68

Plate Thickness: 10

Variations:

DL255B Lock

DL256B Latch



PB



DL261B

DELAMAIN BEADED Knob
on Shaped Backplate
Latch

Dimensions (mm):

Backplate: 172x50

Knob: 51 Dia.

Projection: 68

Plate Thickness: 10

Variations:

DL260B Lock

DL262B Bathroom



PB



DL255SP

**DELAMAIN
SAUSAGE & PEA** Knob
on Long Backplate
Lock

Dimensions (mm):

Backplate:	248x50
Knob:	51 Dia.
Projection:	68
Plate Thickness:	10

Variations:

DL256SP	Latch
DL257SP	Bathroom



DL262SP

**DELAMAIN
SAUSAGE & PEA** Knob
on Shaped Backplate
Bathroom

Dimensions (mm):

Backplate:	172x50
Knob:	51
Projection:	68
Plate Thickness:	10

Variations:

DL260SP	Lock
DL261SP	Latch









DK35C

DELAMAIN PLAIN Knob
Concealed Fix Unsprung

Dimensions (mm):

Rose:	70 Dia.
Knob:	55 Dia.
Projection:	67

-  CP
-  FB
-  PB
-  SC







DK35

DELAMAIN PLAIN Knob
Face Fix Unsprung

Dimensions (mm):

Rose:	70 Dia.
Knob:	55 Dia.
Projection:	65

-  CP
-  FB
-  PB
-  SC









DK36C

DELAMAIN FLOWER Knob
Concealed Fix Unsprung

Dimensions (mm):

Rose: 70 Dia.
Knob: 55 Dia.
Projection: 75

-  CP
-  FB
-  PB
-  SC







DK37C

DELAMAIN REEDED Knob
Concealed Fix Unsprung

Dimensions (mm):

Rose: 70 Dia.
Knob: 51 Dia.
Projection: 83

-  CP
-  FB
-  PB
-  SC



DELAMAIN RANGE

Knobs



DK38

DELAMAIN BEADED Knob
Face Fix Unsprung

Dimensions (mm):

Rose: 70 Dia.

Knob: 55 Dia.

Projection: 70



CP



FB



PB



SC



DK39C

DELAMAIN RINGED Knob
Concealed Fix Unsprung

Dimensions (mm):

Rose: 70 Dia.

Knob: 57 Dia.

Projection: 65



CP



PB



SC

For matching escutcheons DK1-3 and AQ41 see P164-165 and P93/158/165. For matching bathroom turns DK12-13 see P163-164.



DK32WWPB

DELAMAIN WOODEN Knob
Face Fix Unsprung

Dimensions (mm):

Rose:	70 Dia.
Knob:	60 Dia.
Projection:	71



WWPB



DK32WOSC

DELAMAIN WOODEN Knob
Face Fix Unsprung

Dimensions (mm):

Rose:	70 Dia.
Knob:	60 Dia.
Projection:	71



WOSC



DK34ICFB

DELAMAIN PORCELAIN Knob
Face Fix Unsprung

Dimensions (mm):

Rose: 70 Dia.

Knob: 60 Dia.

Projection: 71

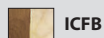

ICFB



DK34MCCP

DELAMAIN PORCELAIN Knob
Face Fix Unsprung

Dimensions (mm):

Rose: 70 Dia.

Knob: 60 Dia.

Projection: 71

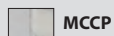

MCCP





DK34PW

DELAMAIN PORCELAIN Knob
Face Fix Unsprung

Dimensions (mm):

Rose:	70 Dia.
Knob:	60 Dia.
Projection:	71



PWCP



PWSC



DK34PBKCP

DELAMAIN PORCELAIN Knob
Face Fix Unsprung

Dimensions (mm):

Rose:	70 Dia.
Knob:	60 Dia.
Projection:	71

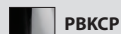

PBKCP



DL250SP

DELAMAIN SAUSAGE & PEA Knob
Face Fix Unsprung

Dimensions (mm):

Rose:	61 Dia.
Knob:	51 Dia.
Projection:	66



DL250B

DELAMAIN BEADED Knob
Face Fix Unsprung

Dimensions (mm):

Rose:	61 Dia.
Knob:	51 Dia.
Projection:	66



For matching finger plates DL252 see P80-81.

**DK60PVD**

GREEK KEY Mortise Knob
Face Fix Unsprung

Dimensions (mm):

Rose: 65x65

Knob: 65

Projection: 79

**PVD**



DELAMAIN RANGE

Finger Plates



DL252B

BEADED Finger Plate

Dimensions (mm):

Backplate: 305x70

Plate Thickness: 6



PB



DL252SP

SAUSAGE AND PEA

Finger Plate

Dimensions (mm):

Backplate: 305x70

Plate Thickness: 6



PB



AC010

ICE CLEAR Crystal Knob
Unsprung

Dimensions (mm):

Rose: 65 Dia.
Knob: 54 Dia.
Projection: 86



CP



PB



SC



AC011

ICE FROSTED Crystal Knob
Unsprung

Dimensions (mm):

Rose: 65 Dia.
Knob: 54 Dia.
Projection: 86



CP



PB



SC

For matching escutcheon AC003 and matching bathroom turn AC004 see P161.



AC013

ICE BUBBLE Crystal Knob
Unsprung

Dimensions (mm):

Rose: 65 Dia.
Knob: 54 Dia.
Projection: 87

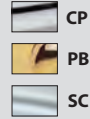

AC020

ICE FACETTED Crystal Knob
Unsprung

Dimensions (mm):

Rose: 65 Dia.
Knob: 54 Dia.
Projection: 83

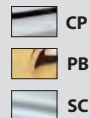

For matching escutcheon AC003 and matching bathroom turn AC004 see P161.



AC033

ICE FROSTED Glass Knob
Unsprung

Dimensions (mm):

Rose: 65 Dia.
Knob: 65 Dia.
Projection: 82



CP



SC



AC050

ICE LARGE Mortice Knob
Unsprung

Dimensions (mm):

Rose: 65 Dia.
Knob: 70 Dia.
Projection: 79



CP



FB



PB



SC

For matching escutcheon AC003 and matching bathroom turn AC004 see P161.



AQ34

OVAL MORTICE Knob
Solid Unsprung

Dimensions (mm):

Rose:	61 Dia.
Knob:	62x30
Projection:	80



CP



PB



AQ35

MUSHROOM MORTICE Knob
Solid Unsprung

Dimensions (mm):

Rose:	61 Dia.
Knob:	53 Dia.
Projection:	73



CP



PB

For matching escutcheon AQ41 see P93/158/165. For matching bathroom turn AQ133 see P160.



M48

BALL MORTICE Knob
Solid Half Sprung

Dimensions (mm):

Rose:	61 Dia.
Knob:	44 Dia.
Projection:	82

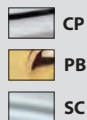

M34

OVAL MORTICE Knob
Half Sprung

Dimensions (mm):

Rose:	61 Dia.
Knob:	55x37
Projection:	73

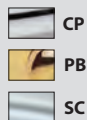

For matching escutcheons AA145-345 see P157. For matching bathroom turn B12 see P160.



M35

MUSHROOM MORTICE Knob
Half Sprung

Dimensions (mm):

Rose: 61 Dia.
Knob: 52 Dia.
Projection: 70

Variations:

M35US Rose 56 Dia.
M35USB Rose 64 Dia.

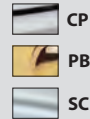

M35C

MUSHROOM MORTICE Knob
Concealed Fix Unsprung

Dimensions (mm):

Rose: 64 Dia.
Knob: 58 Dia.
Projection: 71

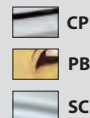

For matching escutcheons AA145-345 see P157. For matching bathroom turn B12 see P160.

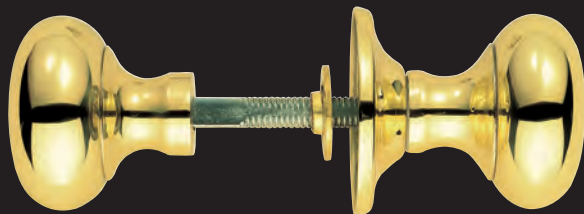

For matching escutcheons AA145-345 see P157
For matching bathroom turn B12 see P160

M35RS

MUSHROOM RIM Knob
Unsprung

Dimensions (mm):

Rose: 56 Dia.
Knob: 52 Dia.

Variations:

M35RB Rose 64 Dia.

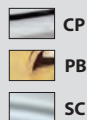

M1001

QUEEN ANNE MORTICE Knob
Unsprung

Dimensions (mm):

Rose: 59 Dia.
Knob: 52 Dia.
Projection: 75

Rim Knob Variations:

M1001R

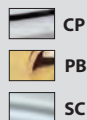

B

For matching escutcheons M1000 see P159
For matching finger plate M1002 see P171
For matching cupboard knobs M1003-5 see FTD catalogue



For matching escutcheon FG21 see P179
For matching bathroom turn FG20 see P179



FG4

GEORGIAN MORTICE Knob
Half Sprung

Dimensions (mm):

Rose: 60 Dia.
Knob: 54 Dia.
Projection: 67



Also available with Short
Latch backplate 110x50mm



FG5

GEORGIAN Knob
on Lock Backplate

Dimensions (mm):

Backplate: 155x50
Knob: 54 Dia.

Variations:

FG5WC Bathroom

Short Plate Variations:

Short Backplate 110x50
FG6 Latch





DL411PVD

EDEN Latch

Dimensions (mm):

Backplate:	180x40
Lever Length:	108
Projection:	67
Plate Thickness:	11

Variations:

DL410PVD	Lock
DL410YPVD	Lock Euro 47.5c/c
DL412PVD	Bathroom



DL67PVD

BIRKDALE Latch

Dimensions (mm):

Backplate:	170x45
Lever Length:	97
Projection:	55
Plate Thickness:	10

Variations:

DL68PVD	Lock
DL68UPVD	Lock Oval 48.5c/c
DL68WCPVD	Bathroom





DL291PVD

MADRID Latch

Dimensions (mm):

Backplate:	242x45
Lever Length:	112
Projection:	57
Plate Thickness:	9

Variations:

DL290PVD	Lock
DL292PVD	Bathroom
DL290YPVD	Lock Euro 47.5c/c



PVD



DL18PVD

ASHTEAD Latch

Dimensions (mm):

Backplate:	168x48
Lever Length:	97
Projection:	58
Plate Thickness:	13

Variations:

DL17PVD	Lock
DL18WCPVD	Bathroom



PVD





AA16WRBPVD

STUDIO H Pull Handle
Without Rose - Bolt Through

Dimensions (mm):

Length: 254
Projection: 70

Variations:

AA16WRAPVD 203
***SPECIAL ORDER**



DL168PVD

OAKLEY Lock

Dimensions (mm):

Backplate: 170x42
Lever Length: 97
Projection: 54
Plate Thickness: 10

Variations:

DL167PVD Latch
DL168WCPVD Bathroom
DL168UPVD Lock Oval 48.5c/c
DL168YPVD Lock Euro 47.5c/c



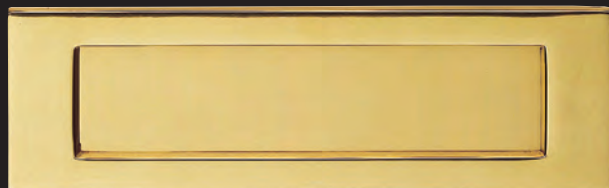

M36SPVD

LETTERPLATE

Dimensions (mm):

Outer Frame:	257x80
Aperture:	185x40
Flap:	195x46
Fixing Centres:	220

Variation M36HPVD:

Outer Frame:	282x80
Aperture:	230x50
Flap:	236x56
Fixing Centres:	260



AQ41PVD

ESCUTCHEON

Dimensions (mm): 42 Dia.



AQ40PVD

ARCHITECTURAL QUALITY CYLINDER LATCH PULL

Dimensions (mm):

Overall: 76x45

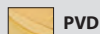

**M38BPVD****URN** Door Knocker**Dimensions (mm):**

Height:	202
Fixing Centres:	126



PVD

**DL219PVD****CENTRE** Door Knob**Dimensions (mm):**

Rose:	80
Knob:	74
Projection:	75



PVD





AQ31PVD

BELL PUSH

Dimensions (mm):

Overall: 76x38



PVD



N5PVD

NUMERAL 5

Dimensions (mm):

Height: 76

Variations:

- N0PVD** Numerals 0
- N1PVD** Numerals 1
- N2PVD** Numerals 2
- N3PVD** Numerals 3
- N4PVD** Numerals 4
- N6/9PVD** Numerals 6 or 9
- N7PVD** Numerals 7
- N8PVD** Numerals 8



PVD





M220

EASY CENTRE

Door Knob

Dimensions (mm):

Rose: 55 Dia.

Knob: 70 Dia.

Projection: 80



CP



PB



SC



M49

OCTAGONAL CENTRE

Door Knob

Dimensions (mm):

Rose: 65 Dia.

Knob: 56 Dia.

Projection: 75



PB



M219

OCTAGONAL CENTRE

Door Knob

Dimensions (mm):

Rose: 79 Dia.

Knob: 64 Dia.

Projection: 75



CP



PVD



M60

ROUND CENTRE

Door Knob

Dimensions (mm):

Rose: 79 Dia.

Knob: 66 Dia.

Projection: 80



CP



FB



PB



SC





M33

OCTAGONAL CENTRE

Door Knob

Dimensions (mm):

Rose: 79 Dia.

Knob: 66 Dia.

Projection: 79

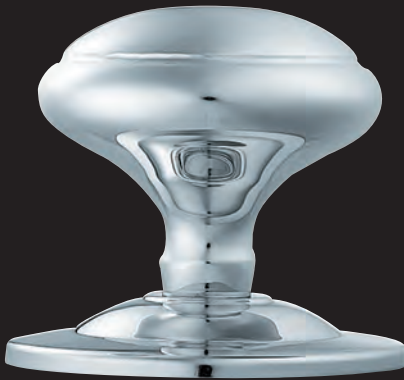

M61

ROUND CENTRE

Door Knob

Dimensions (mm):

Rose: 85 Dia.

Knob: 73 Dia.

Projection: 75





M51

CENTRE

Door Knob

Dimensions (mm):

Rose:	86 Dia.
Knob:	70 Dia.
Projection:	75



CP



PB



SC



AC055

LARGE CENTRE

Door Knob

Dimensions (mm):

Rose:	90 Dia.
Knob:	100 Dia.
Projection:	95



CP



FB



PB



SC

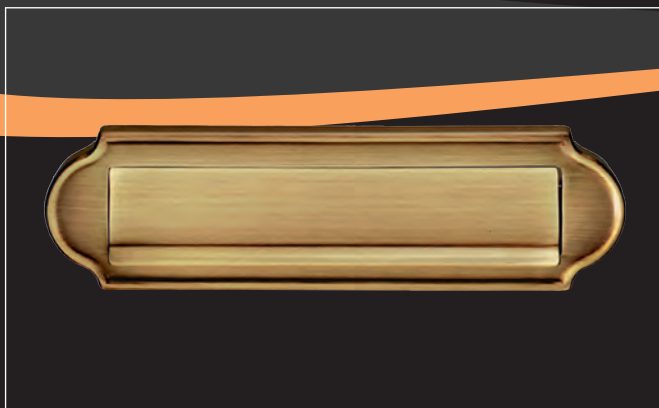

DL348

WENTWORTH Letter Plate

Dimensions (mm):

Outer Frame:	280x78
Aperture:	215x42
Fixing Centres:	252



DL347

NEW WENTWORTH Letter Plate

Dimensions (mm):

Outer Frame:	275x76
Aperture:	215x42
Fixing Centres:	250



DL19

ASHTEAD Letter Plate
Gravity Flap

Dimensions (mm):

Outer Frame:	280x78
Aperture:	215x42
Fixing Centres:	252





M36G

PLAIN LETTER PLATE

Gravity Flap

Dimensions (mm):

Outer Frame: 270x73

Aperture: 202x45

Fixing Centres: 253



CP



PB



SC



M78

POSTAL KNOCKER

Dimensions (mm):

Outer Frame: 256x79

Aperture: 196x44

Fixing Centres: 226



CP



PB



To suit Euroline Collection
see P56-57

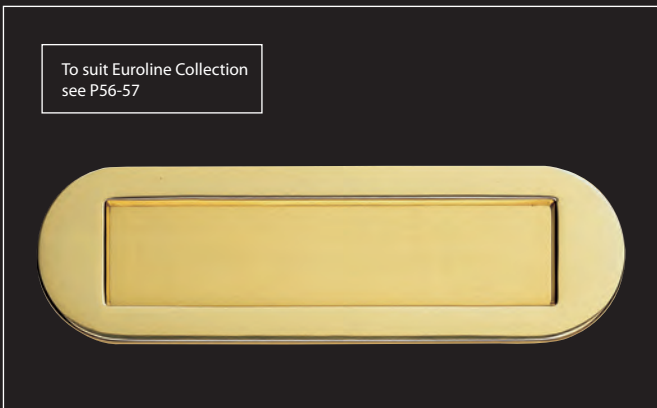

M304

ROUND LETTER PLATE

Round End

Dimensions (mm):

Outer Frame: 258x79

Aperture: 195x44

Fixing Centres: 225



CP



PB



SC

M36H PB and SC available only as special finishes
AA56 also available in satin chrome

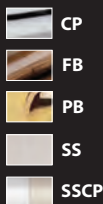
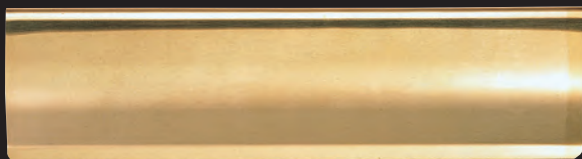
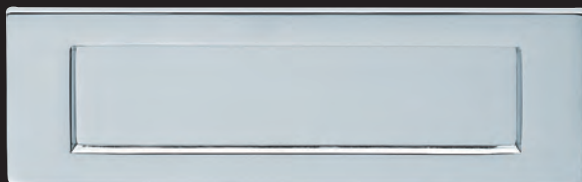
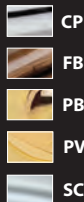

M36S

PLAIN Letter Plate B

Dimensions (mm):

Outer Frame: 257x80
Aperture: 185x40
Fixing Centres: 220

Variations:

M36H

Outer Frame: 282x80
Aperture: 230x50
Fixing Centres: 260

Finish: PB

M36A (Contract)

Outer Frame: 254x76
Aperture: 192x40
Fixing Centres: 230

Finishes: CP/PB/SC

M36B

Outer Frame: 276x94
Aperture: 211x53
Fixing Centres: 242

M36C

Outer Frame: 203x75
Aperture: 158x42
Fixing Centres: 182

M36F

Outer Frame: 402x124
Aperture: 321x71
Fixing Centres: 360

M36D

Outer Frame: 305x103
Aperture: 248x60
Fixing Centres: 275

M36E

Outer Frame: 359x113
Aperture: 284x63
Fixing Centres: 326

AA53

LETTER TIDY Curved Pattern

Dimensions (mm): 280x76

Finishes: PB/SS/SSCP
AA52 300x95

Finishes: CP/PB
AA54 Foam Lined 280x76

Variations:
AA56 355x127



M37

RING Door Knocker

Dimensions (mm):

Ring:	134 Dia.
Fixing Plate:	78.5 Dia.
Strike Plate:	35 Dia.



CP



PB



SC



DL370B

BEADED Door Knocker

Dimensions (mm):

Ring:	134 Dia.
Fixing Plate:	59.5 Dia.
Strike Plate:	45 Dia.



PB



M45

DOCTOR KNOCKER

Dimensions (mm):

Overall: 186x34

Rose: 55 Dia.



CP



FB



PVD



SC



M46

**DOOR KNOCKER
ON BACKPLATE**

Dimensions (mm):

Backplate: 135x39

Centres: 95

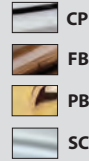

M43

**DOOR KNOCKER
ON ROSE**

Dimensions (mm):

Overall Length: 140

Centres: 95

Rose: 42 Dia.

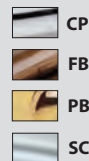





AA31

BELL PUSH

Dimensions (mm):

Overall: 76x25

-  CP
-  PB
-  SC

(B)







AQ31

BELL PUSH

Dimensions (mm):

Overall: 76x38

-  CP
-  FB
-  PB
-  PVD
-  SC

(B)



N3

NUMERAL 3

Dimensions (mm):

Height: 76

Variations:

N0	Numeral 0
N1	Numeral 1
N2	Numeral 2
N4	Numeral 4
N5	Numeral 5
N6/9	Numeral 6 or 9
N7	Numeral 7
N8	Numeral 8



CP



FB



PB



SC

B



NA

LETTER A

Face Fix

Dimensions (mm):

Height: 53

Variations:

NB	Letter B
NC	Letter C
ND	Letter D



CP



PB



SC

B



M38S

URN Door Knocker

Dimensions (mm):

Height: 152
Centres: 95

Finishes: CP/PB/PVD

M38B

Height: 202
Centres: 126



CP



FB



PB

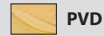

PVD

B



AA75

HEAVY DOOR CHAIN

Breaking Strain 180 Newtons

Dimensions (mm):

Chain Retainer: 60x16
Chain Overall: 200
Angle Plate: 46x32x38



CP



PB



SC

B



AQ40

**ARCHITECTURAL QUALITY
CYLINDER PULL**

Dimensions (mm):

Overall: 76x45



(B)



M40

CYLINDER LATCH PULL

Dimensions (mm):

Overall: 72x48



(B)



AA76

DOOR VIEWER Plastic Lens

Viewing Angle 180°

To suit 34-54mm doors

Dimensions (mm):

Tube: 13.7 Dia.

Variations:

AA77 Glass Lens



(B)



FG8XL

LARGE LION HEAD

Door Knocker

Dimensions (mm):

Backplate: 202x224

Knocker: 226x242



FG8C

LION HEAD

Door Knocker

Complete with strike plate

Dimensions (mm):

Overall: 230x140

Centres: 142





MB10

LION HEAD NO. 10

Door Knocker
Old English Style
Complete with strike plate

Dimensions (mm):

Overall: 230x120
Centres: 126



PB



FG15

GEORGIAN CENTRE

Door Knob

Dimensions (mm):

Rose: 75 Dia.
Knob: 62 Dia.
Projection: 80



PB





FG7S

GEORGIAN Letter Plate

Dimensions (mm):

Outer Frame:	254x76
Aperture:	192x45
Fixing Centres:	224

Variations:

FG7B

Outer Frame:	278x90
Aperture:	204x47
Fixing Centres:	230



FG25

GEORGIAN Postal Knocker

Dimensions (mm):

Outer Frame:	254x76
Aperture:	191x45
Fixing Centres:	224

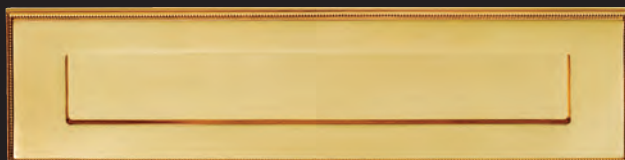

DL107B

**REGENCY BEADED
Letter Plate**

Dimensions (mm):

Outer Frame:	320x80
Aperture:	255x35
Fixing Centres:	290





FG9

**GEORGIAN CYLINDER
LATCH PULL**

Dimensions (mm):

Overall: 76x45



DL9

**REGENCY CYLINDER
LATCH PULL**

Dimensions (mm):

Overall: 76x45



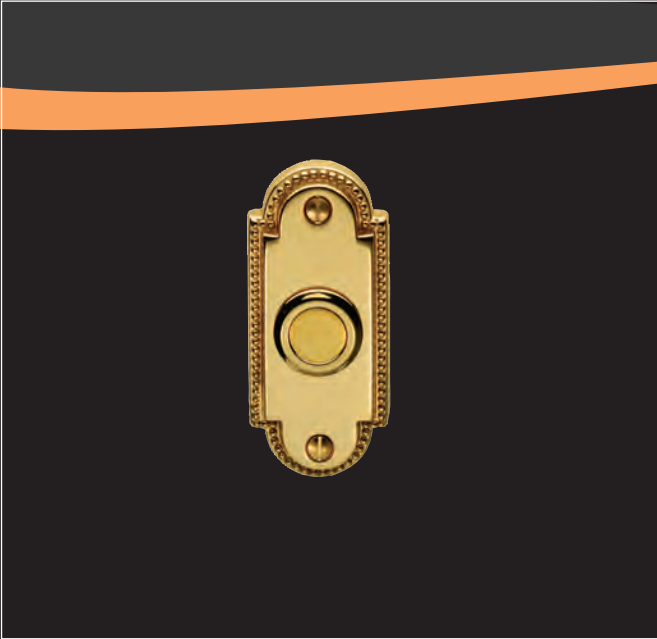

AA29

REGENCY Bell Push

Dimensions (mm):

Overall: 80x32

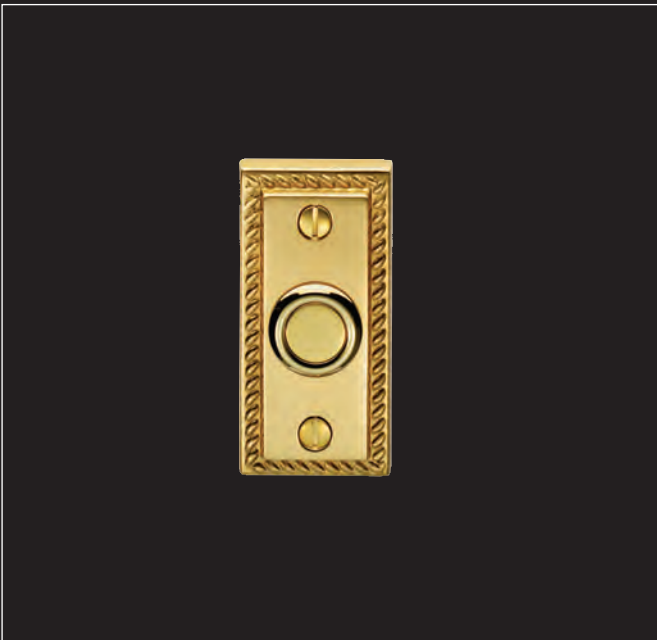

AA30

GEORGIAN Bell Push

Dimensions (mm):

Overall: 76x25





FG11S

GEORGIAN URN

Door Knocker

Dimensions (mm):

Height: 152

Centres: 96

Variations:

FG11B

Height: 202

Centres: 123



**PF100R****LARGE PULL HANDLE**

Right Hand

Dimensions (mm):

Backplate:	457x76
Handle Length:	334
Projection:	90.5
Plate Thickness:	4.5

Variations:**PF101L** Left Hand**CP *SPECIAL ORDER****PB****PF102****LARGE PUSH PLATE****Dimensions (mm):**

Backplate:	457x76
Plate Thickness:	4.5

**PB**

**PF103ER****ENGRAVED LARGE
PULL HANDLE**
Right Hand**Dimensions (mm):**

Backplate: 457x76

Handle Length: 334

Projection: 90.5

Variations:**PF104EL** Left Hand**PF105E****ENGRAVED PUSH PLATE****Dimensions (mm):**

Backplate: 457x76

Plate Thickness: 4.5





PF109AR

LAURIN PULL HANDLE

Right Hand

Dimensions (mm):

Backplate: 377x42

Handle Length: 274

Projection: 51

Variations:

PF109AL Left Hand



PB



PF110

LAURIN FINGER PLATE

Dimensions (mm):

Backplate: 370x64



PB



PF106

ORNATE PULL HANDLE**Dimensions (mm):**

Backplate:	382x64
Handle Length:	270
Projection:	69



CP



PB



PF107

FINGER PLATE**Dimensions (mm):**

Backplate:	382x64
------------	--------



CP



PB

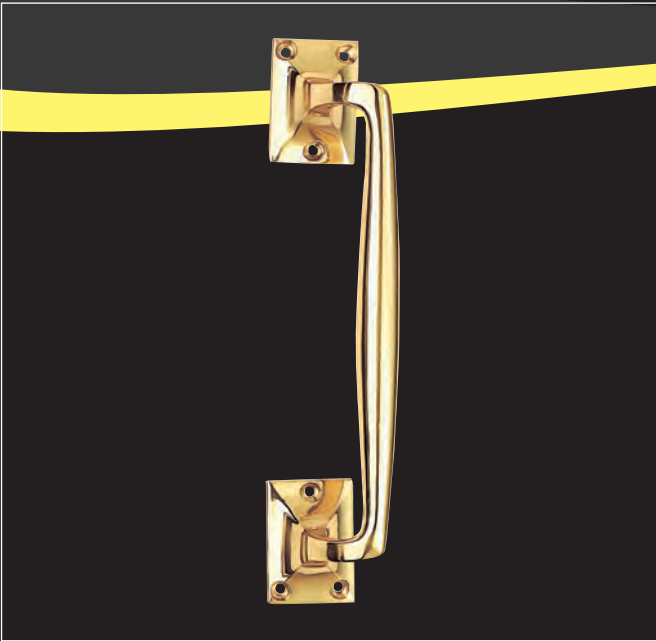

AA92

PUB STYLE PULL HANDLE

Dimensions (mm):

Total Length: 254
 Handle Length: 200
 Projection: 47

Finish: PB
AA93
 Total Length: 305



CP



PB



SC



AA90

CRANKED PULL HANDLE

Dimensions (mm):

Handle Length: 230
 Projection: 47

Finish: PB
AA91
 Handle Length: 305



CP



PB



AA36

BOW HANDLE**Dimensions (mm):**

Total Length: 152
Projection: 20

Finish: PB

AA36L
Total Length: 175
Projection: 25



MB37

VICTORIAN PULL HANDLE

Left/Right Handed Pairs

Dimensions (mm):

Handle Length: 202
Projection: 46





AA95

CAST PULL HANDLE

Dimensions (mm):

Backplate:	295x60.5
Handle Length:	170
Projection:	65
Plate Thickness:	5



PB



AA16WRB

STUDIO H PULL HANDLE

Bolt Through

Dimensions (mm):

Centres:	254
Projection:	70

Variations:

AA16WRA	
Centres:	203



CP



PB



PVD

AA16WRB - CP only available as special finish
AA16WRA - CP and PVD only available as special finishes



For matching lever
AQ4 see P22
AA14B - CP and SC only
available as special finishes

AA14A

CALLA PULL HANDLE

on Rose

Dimensions (mm):

Length:	229
Centres:	200
Rose:	51 Dia.
Projection:	56

Finish: PB**AA14B**

Length:	350
Centres:	300



For matching lever
AQ1 see P21

AA15

STELLA PULL HANDLEon Rose
Concealed Fix**Dimensions (mm):**

Length:	229
Centres:	196
Rose:	51 Dia.
Projection:	73.





For matching lever
AQ2 see P21
Also available without rose
AA16WRA see P92/122
AA16A and C - SC only
available as special finish

AA16B

STUDIO H PULL HANDLE

on Rose
Concealed Fix

Dimensions (mm):

Length: 229
Rose: 51 Dia.
Projection: 71

Finishes:

CP/PB

AA16A
Length: 150
AA16C
Length: 305
AA16D
Length: 380
AA16E
Length: 450

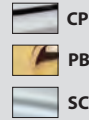

For matching lever
AQ6 see P22

AA17

ESPRIT PULL HANDLE

On Rose
Concealed Fix

Dimensions (mm):

Length: 229
Rose: 51 Dia.
Projection: 51

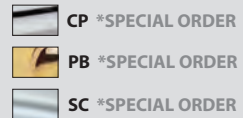



For matching lever
AQ7 see P23

AA18

ESPRIT 2 PULL HANDLE
on Rose
Concealed Fix

Dimensions (mm):

Length: 229
Rose: 51 Dia.
Projection: 51



For matching lever
AQ5 see P22

AA19

VERONICA PULL HANDLE
On Rose
Concealed Fix

Dimensions (mm):

Length: 229
Rose: 51 Dia.
Projection: 62





DL611

CHESHAM PULL HANDLE

Dimensions (mm):

Backplate:	300x55
Handle Length:	300
Projection:	60



PB



FG16

GEORGIAN BOW HANDLE

Dimensions (mm):

Length:	178
Rose:	35 Dia.
Projection:	50



PB



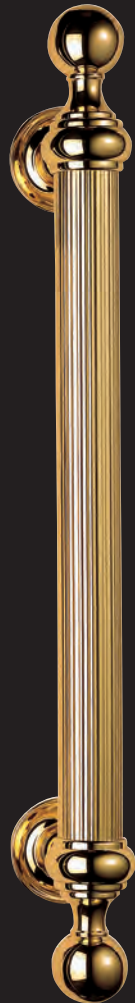

PF108

**REEDED GRIP
PULL HANDLE**

Bolt Through

Dimensions (mm):

Length:	500
Rose:	56 Dia.
Projection:	80
Centres:	352
Diameter:	30



PB

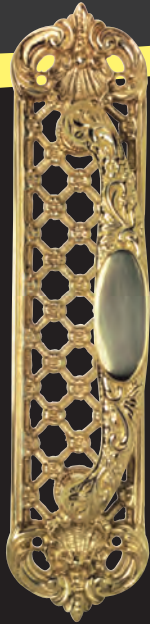

For matching
fingerplate MB3 see P180

MB40

ORNATE PULL HANDLE

Trellis

Dimensions (mm):

Backplate: 305x70

Handle Length: 200

Projection: 50



PB

**SZS73****CASEMENT FASTENER**

Not Suitable for Weather Stripped Windows

Dimensions (mm):

Length: 120

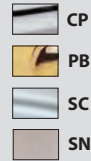
**SZS44S****CASEMENT STAY****Dimensions (mm):**

Length: 254

Variations:

SZS44C 203

SZS44B 305

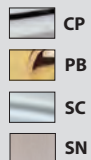



WF30

**SQUARE CASEMENT
FASTENER**

Complete with Hook Plate
and Flat Keep
Suitable for Weather
Stripped Windows

Dimensions (mm):

Length: 125

 SS



WF32

SQUARE CASEMENT STAY

Dimensions (mm):

Length: 253

 SS



WF35

**SQUARE LOCKING
ESPAG FASTENER**

Dimensions (mm):

Length: 125



WF21

**ROUND CASEMENT
FASTENER**

Complete with Hook Plate
and Flat Keep
Suitable for Weather
Stripped Windows

Dimensions (mm):

Length: 125

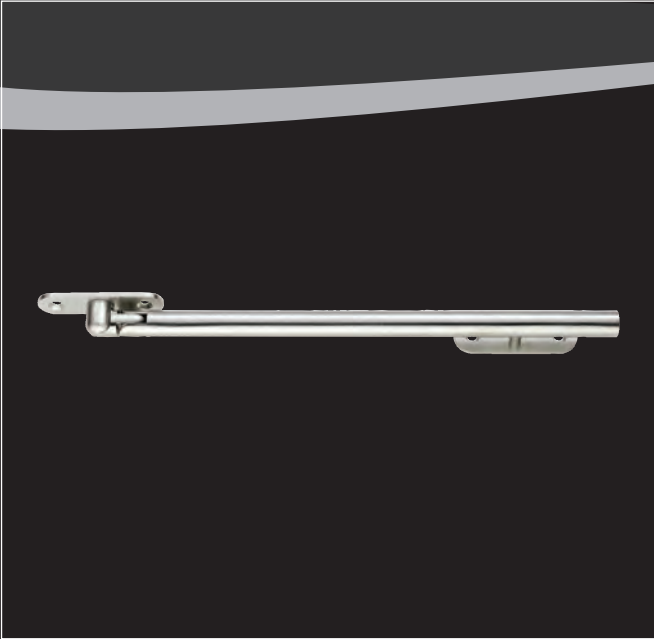

**WF22S****ROUND CASEMENT STAY****Dimensions (mm):**

Length: 253

Variations:**WF23** 203**WF24** 305

SS

**WF25****ROUND LOCKING ESPAG
FASTENER****Dimensions (mm):**

Length: 125



SS

**WF12S****BULB END CASEMENT STAY****Dimensions (mm):**

Length: 253

Finishes: CP/PB/SC**WF12C** 203**Finishes:** CP/PB/SC**WF12B** 305

CP



FB



PB

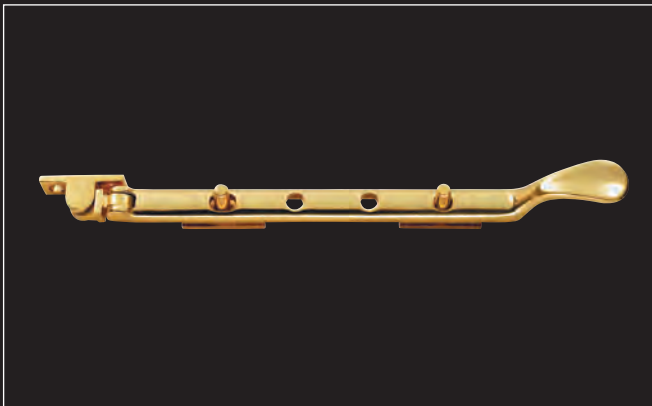

SC

**M44S****VICTORIAN CASEMENT STAY****Dimensions (mm):**

Length: 254

Variations:**M44C** 202**M44B** 305

CP



PB

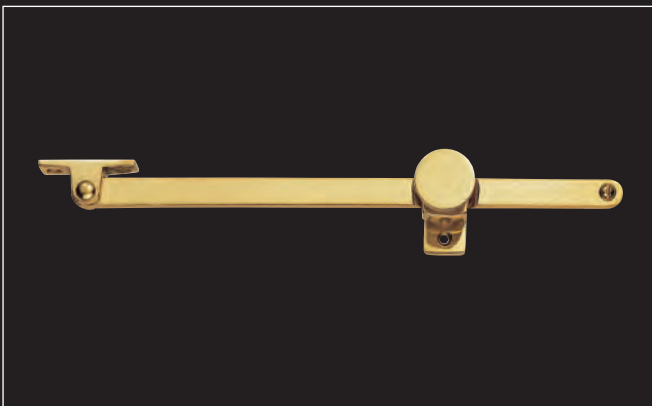

SC

**AA73****SCREW DOWN PATTERN CASEMENT STAY****Dimensions (mm):**

Length: 254



PB

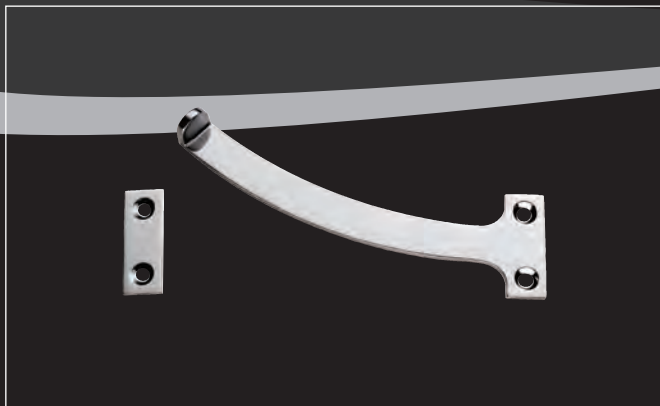

DK7

QUADRANT ARM STAY

Sold in Pairs

Dimensions (mm):

Length: 150



CP



PB



SC

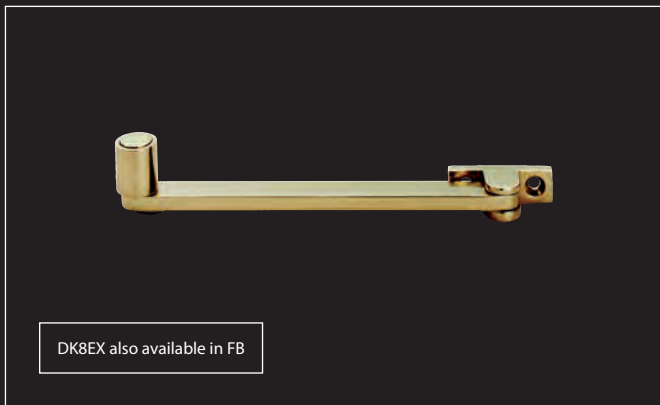

DK8EX also available in FB

DK8

ROLLER ARM STAY

Dimensions (mm):

Length: 150

Variations:

DK8EX 38mm Extended Roller



CP



PB



SC



FG17S

GEORGIAN CASEMENT STAY

Dimensions (mm):

Length: 254



PB



DL44S

**BEADED DELUXE
CASEMENT STAY****Dimensions (mm):**

Length: 254

Variations:

DL44B 305



PB



AA96

SASH HANDLE**Dimensions (mm):**

Length: 102

Variations:

AA97 152



CP



PB



SC

B

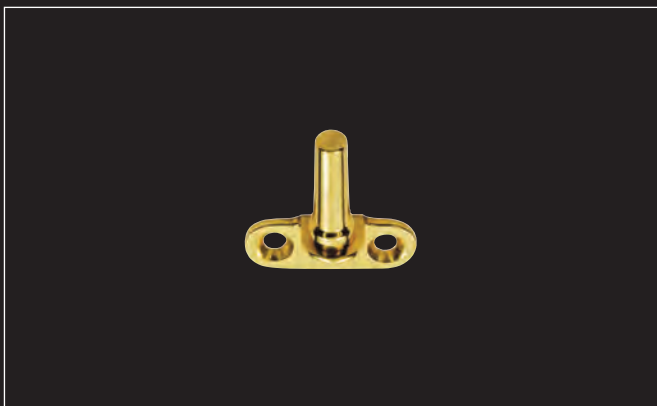

WF14

**PIN FOR FLUSH FITTING
CASEMENT****Dimensions (mm):**

Overall: 42x39



CP



PB



SC



WF15

EJMA PIN

9° Bevel for EJMA Windows

Dimensions (mm):

Plate: 40x15
Height: 27



CP



PB



SC



WF17

**LOCKING CASEMENT
STAY PIN**

Dimensions (mm):

Plate: 40x15
Height: 35



CP



PB



PCB



SC



V1006LCK

**LOCKING CASEMENT
FASTENER**

Wedge Pattern Locking
Suitable for Weather Stripped
Windows

Dimensions (mm):

Overall: 13x57



CP



PB



SC

**V1008LH/RH****CRANKED LOCKING
ESPAG. HANDLE**

V1008LH - Left Hand

V1008RH - Right Hand

Suitable for Weather Stripped
Windows**Dimensions (mm):**

Length: 110

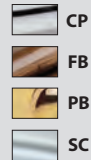
**WF11****BULB END CASEMENT
FASTENER**Both Hook and Mortice Plate
Suitable for Weather Stripped
Windows**Dimensions (mm):**

Length: 98

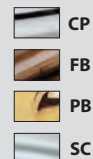
Variations:**WF16** Mortice Plate Only
Suitable for Standard
Windows



V1007LCK

**VICTORIAN LOCKING
CASEMENT FASTENER
WITH NIGHT VENT**

Suitable for Weather
Stripped Windows

Dimensions (mm):

Backplate: 16x60

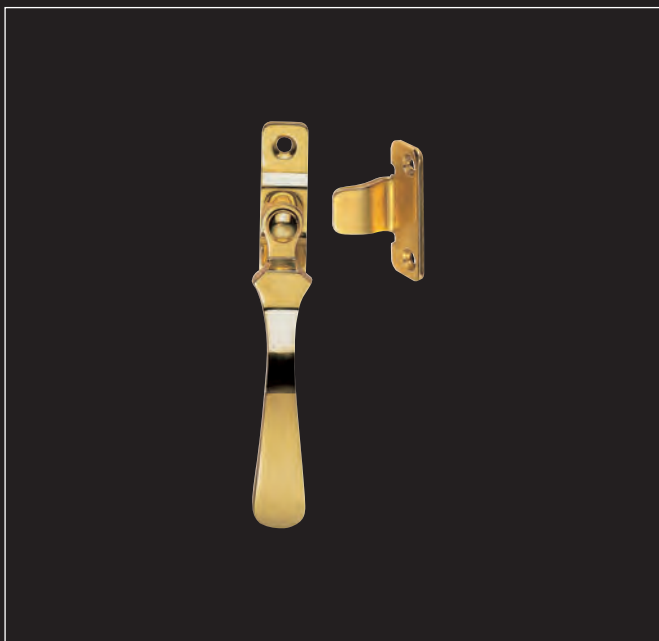
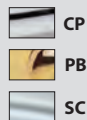

V1005

CASEMENT FASTENER

Wedge Pattern
Not Suitable for Weather
Stripped Windows

Dimensions (mm):

Backplate: 57x13

Variations:

V1005LCK

Wedge Pattern
Locking Casement Fastener
Backplate: 57x13

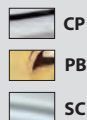

**DL51****BEADED CASEMENT FASTENER**

Both Hook and Mortice Plate
Not Suitable for Gasket Sealed
Windows

Dimensions (mm):

Backplate: 70x20



PB

**M73****CASEMENT FASTENER REVERSIBLE**

Reversible Pattern
Both Hook and Mortice Plate
Not Suitable for Weather
Stripped Windows

Dimensions (mm):

Backplate: 57x13



CP



PB



SC



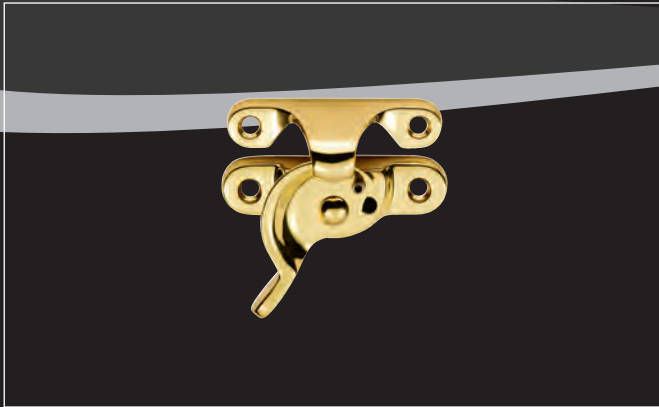

AA40

FITCH PATTERN SASH FASTENER

Dimensions (mm):

Overall: 64x25

Variations:

AA40LCK

Locking Fitch Pattern Sash Fastener



CP



PB



SC



AQ39

ARCHITECTURAL QUALITY QUADRANT SASH FASTENER

Dimensions (mm):

Overall: 70x20



CP



PB



PVD



SC



AQ43

ARCHITECTURAL QUALITY BRIGHTON SASH FASTENER

Dimensions (mm):

Overall: 57x20



CP



PB



SC





AA39

**QUADRANT ARM
SASH FASTENER**
Dimensions (mm):

Overall: 70x20



PB

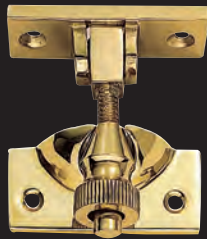

AA41

**BRIGHTON PATTERN
SASH FASTENER**
Dimensions (mm):

Overall: 57x20



PB



DK42

FAN LIGHT CATCH
Dimensions (mm):

Overall: 45x45



CP



PB



SC

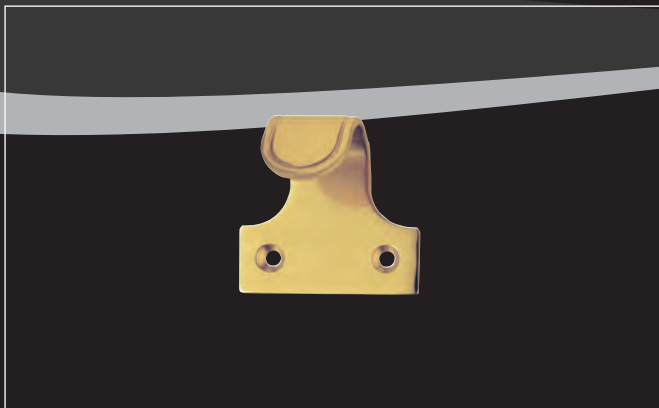

AQ42

**ARCHITECTURAL
SASH LIFT**

Dimensions (mm): 52



CP



PB



SC

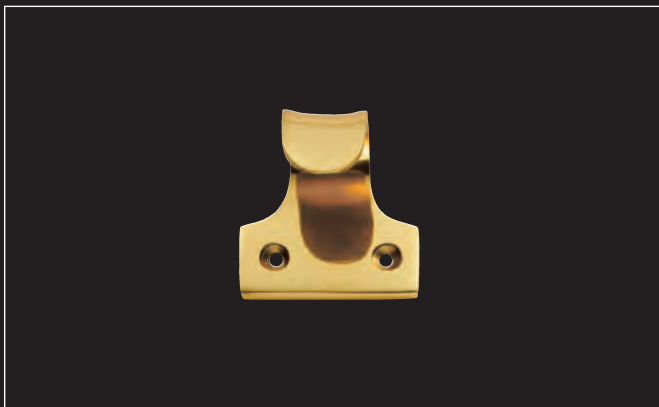

AA42

CONTRACT SASH LIFT

Dimensions (mm): 51



PB



AA42RI

RING SASH LIFT

Vertical Fix

Dimensions (mm): 51

Variations:

AA42R

Horizontal Fix: 45x13



PB



AQ50

SASH WINDOW LIFT

Dimensions (mm): 64



CP



PB



SC



AQ91

**SASH WINDOW AXLE
PULLEY**

Galv Forend with Nylon Wheel

Dimensions (mm):

Forend: 117x25

Body: 76x39

Pulley: 42 Outer Dia.

Wheel Thickness: 10



GALV



AQ92

**SASH WINDOW AXLE
PULLEY**

Square Forend with
Nylon Wheel

Dimensions (mm):

Forend: 117x25
Body: 76x39
Pulley: 42 Outer Dia.
Wheel Thickness: 10

Variations:

AQ96

Heavy Duty Radius Forend
with Brass Wheel

Dimensions (mm):

Forend: 127x28
Body: 83x52
Pulley: 50 Outer Dia.
Wheel Thickness: 13



CP



PB



AQ93

**SASH WINDOW AXLE
PULLEY**

Square Forend with
Brass Wheel

Dimensions (mm):

Forend: 117x25
Body: 76x39
Pulley: 42 Outer Dia.
Wheel Thickness: 10



PB

**SZC001****EURO ESCUTCHEON**

Concealed Fix
Push-on-Rose

Dimensions (mm):

Rose: 51 Dia.



CP



SC

**SZC002****OVAL ESCUTCHEON**

Concealed Fix
Push-on-Rose

Dimensions (mm):

Rose: 51 Dia.



CP



SC

**SZC003****STANDARD ESCUTCHEON**

Concealed Fix
Push-on-Rose

Dimensions (mm):

Rose: 51 Dia.



CP



SC





SZC004

**THUMBTURN AND
RELEASE**

Concealed Fix
Push-on-Rose

Dimensions (mm):

Rose: 51 Dia.



CP



SC



**SZM001****EURO ESCUTCHEON**

Concealed Fix
Screw-on-Rose

Dimensions (mm):

Rose: 51 Dia.



BN



CP



SC

**SZM002****OVAL ESCUTCHEON**

Concealed Fix
Screw-on-Rose

Dimensions (mm):

Rose: 51 Dia.



CP



SC

**SZM003****STANDARD ESCUTCHEON**

Concealed Fix
Screw-on-Rose

Dimensions (mm):

Rose: 51 Dia.



BN



CP



SC





SZM001SQ

**SQUARE EURO
ESCUTCHEON**

Concealed Fix
Screw-on-Rose

Dimensions (mm): 51.5x51.5



BN



CP



SC



SZM002SQ

**SQUARE OVAL
ESCUTCHEON**

Concealed Fix
Screw-on-Rose

Dimensions (mm): 51.5x51.5



CP



SC



SZM003SQ

**SQUARE STANDARD
ESCUTCHEON**

Concealed Fix
Screw-on-Rose

Dimensions (mm): 51.5x51.5



BN



CP



SC

**SZM004****THUMBTURN AND
RELEASE**

Concealed Fix
Screw-on-Rose

Dimensions (mm):

Rose: 51 Dia.

 BN

 CP

 SC

(B)

**SZM004SQ****THUMBTURN AND
RELEASE**

Concealed Fix
Screw-on-Rose

Dimensions (mm):

Rose: 51.5x51.5

 BN

 CP

 SC

(B)

**SZS004****THUMBTURN AND
RELEASE**

Concealed Fix
Screw-on-Rose

Dimensions (mm):

Rose: 51 Dia.

Spindle: 4.9

 BN

 CP

 SC

(B)



AA1

EURO ESCUTCHEON

Concealed Fix

Dimensions (mm):

Rose: 50 Dia.



BN



CP



PB



SC

(B)



AA2

OVAL ESCUTCHEON

Concealed Fix

Dimensions (mm):

Rose: 50 Dia.



BN



CP



PB



SC

(B)



AA3

STANDARD ESCUTCHEON

Concealed Fix

Dimensions (mm):

Rose: 50 Dia.



BN



CP



PB



SC

(B)



AQ12

**STANDARD THUMBTURN
AND RELEASE**

Concealed Fix

Dimensions (mm):

Rose: 50 Dia.

Spindle: 4.9x67



CP



PB



SC



AQ11

**THUMBTURN AND
RELEASE WITH INDICATOR**

Concealed Fix

Dimensions (mm):

Rose: 50 Dia.

Spindle: 4.9x67



CP



PB



SC



AA10

**THUMBTURN AND
RELEASE**

Concealed Fix

Dimensions (mm):

Rose: 50 Dia.

Spindle: 8x75



CP *SPECIAL ORDER



PB



SC *SPECIAL ORDER



AA12

**STANDARD THUMBTURN
AND RELEASE** Concealed Fix

Dimensions (mm):

Rose: 50 Dia.

Spindle: 4.9x67

Variations:

AA12L

Spindle: 4.9x80



CP



PB



SC

B



ESB005

**DESIGNER BLIND
ESCUTCHEON****Dimensions (mm):**

Rose: 51 Dia.

Rose Thickness: 10



CP



SC



ESE005

**DESIGNER EURO
ESCUTCHEON****Dimensions (mm):**

Rose: 51 Dia.

Rose Thickness: 10



CP



PB



SC



ESP005

**DESIGNER LEVER LOCK
ESCUTCHEON****Dimensions (mm):**

Rose: 51 Dia.

Rose Thickness: 10



CP



PB



SC



ESU005

**DESIGNER OVAL
ESCUTCHEON**

Dimensions (mm):

Rose: 51 Dia.
Rose Thickness: 10



CP



PB



SC



EST004

**DESIGNER THUMBTURN
AND RELEASE**

Dimensions (mm):

Rose: 51 Dia.
Rose Thickness: 10



CP



PB



SC

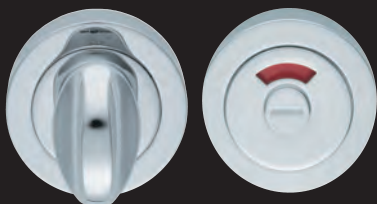

EST004 - i

**DESIGNER THUMBTURN
AND RELEASE**

c/w Indicator

Dimensions (mm):

Rose: 51 Dia.
Rose Thickness: 10



CP



PB



SC

**EST005****DESIGNER THUMBTURN
AND RELEASE****Dimensions (mm):**

Rose: 51 Dia.

Rose Thickness: 10



CP



PB



SC

**ZET3025****DISABLED THUMBTURN
AND RELEASE****Dimensions (mm):**

Rose: 51 Dia.

Rose Thickness: 10



PC



SC

**ZET3025i****DISABLED THUMBTURN
AND RELEASE**

c/w Indicator

Dimensions (mm):

Rose: 51 Dia.

Rose Thickness: 10



PC



SC



ERO006

**DESIGNER SQUARE
EASI-ROSE**

Replacement Outer Rose to
Customise the Designer Range

Dimensions (mm):

Rose: 55x55

Rose Thickness: 10



CP



PB



SC



ERO007

**DESIGNER OVAL
EASI-ROSE**

Replacement Outer Rose to
Customise the Designer Range

Dimensions (mm):

Rose: 68x55

Rose Thickness: 10



CP



PB



SC



ERO008

**DESIGNER HEXAGON
EASI-ROSE**

Replacement Outer Rose to
Customise the Designer Range

Dimensions (mm):

Rose: 64x55

Rose Thickness: 10



CP



PB



SC



AA145

EURO ESCUTCHEON**Dimensions (mm):**

Rose: 45 Dia.



CP



PB



SC



AA245

OVAL ESCUTCHEON**Dimensions (mm):**

Rose: 45 Dia.



CP



PB



SC



AA345

STANDARD ESCUTCHEON**Dimensions (mm):**

Rose: 45 Dia.



CP



PB



SC



AQ41

SMALL ESCUTCHEON

Dimensions (mm):

Rose: 42 Dia.



CP



FB



PB



PVD



SC



AQ45

**ARCHITECTURAL QUALITY
COVERED ESCUTCHEON**

Pear Drop

Dimensions (mm):

Overall: 59x18



CP



PB



AA4

**SQUARE STANDARD
ESCUTCHEON**

Dimensions (mm):

Overall: 51x51

Variations:

AA5 Euro 51x51

AA6 Oval 51x51



PB



M42

COVERED ESCUTCHEON

Dimensions (mm):

Rose: 32 Dia.



CP



PB



SC



M41

FLAT STANDARD ESCUTCHEON

Dimensions (mm):

Rose: 32 Dia.



CP



PB



SC

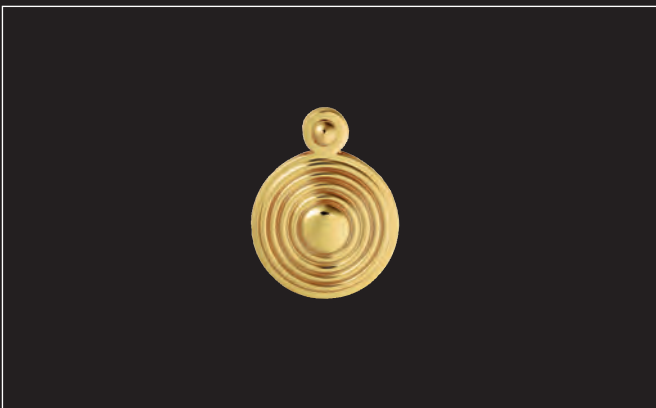

M1000

QUEEN ANNE COVERED ESCUTCHEON

Dimensions (mm):

Rose: 32 Dia.



CP



FB



PB



SC



Extension piece SP85
available for 40-54mm doors

AQ133

**OVAL THUMBTURN
AND RELEASE**

To suit Bathroom Lock

Dimensions (mm):

Rose: 45 Dia



B12

**PLAIN THUMBTURN
AND RELEASE**

Dimensions (mm):

Rose: 45 Dia.

Spindle: 4.9x67

Finishes: PB/SC

B12L

Spindle: 4.9x80









AC003

**ICE STANDARD
ESCUTCHEON**

Dimensions (mm):

Rose: 45 Dia.

-  CP
-  FB
-  PB
-  SC







AC004

**ICE THUMBTURN AND
RELEASE**

Dimensions (mm):

Rose: 45 Dia.

-  CP
-  FB
-  PB
-  SC



DK14PVD

GREEK KEY THUMBTURN AND RELEASE

Dimensions (mm):
Overall: 45x45



PVD



DK17PVD

GREEK KEY COVERED ESCUTCHEON

Dimensions (mm):
Overall: 45x45

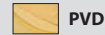

PVD



DK18PVD

GREEK KEY ESCUTCHEON

Dimensions (mm):
Overall: 45x45



PVD



DL1000SP

SAUSAGE AND PEA COVERED STANDARD ESCUTCHEON

Dimensions (mm):
Rose: 32 Dia.

Variations:
DL1000B Beaded

 PB



DL133B

BEADED OVAL THUMBTURN AND RELEASE

Dimensions (mm):
Rose: 32 Dia.

Variations:
DL133SP Sausage and Pea

 PB





DK12

LARGE THUMBTURN AND RELEASE

Dimensions (mm):
Rose: 55 Dia.

 CP

 FB

 PB

 SC

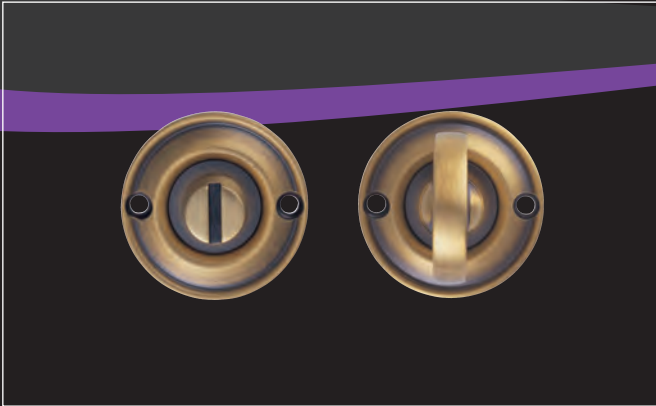

DK13

SMALL THUMBTURN AND RELEASE

Dimensions (mm):

Rose: 42 Dia.



CP



FB



PB



SC



DK1

EURO ESCUTCHEON

Dimensions (mm):

Rose: 55 Dia.



CP



FB



PB



SC



DK2

OVAL ESCUTCHEON

Dimensions (mm):

Rose: 55 Dia.



CP



FB



PB



SC







To suit horizontal, DIN size or UK deadlocks

DK3

STANDARD ESCUTCHEON

Dimensions (mm):

Rose: 55 Dia.

-  CP
-  FB
-  PB
-  SC







To suit standard UK lock case

AQ41

ESCUTCHEON

Dimensions (mm):

Rose: 42 Dia.

-  CP
-  FB
-  PB
-  SC





DK4

LARGE COVERED ESCUTCHEON

Dimensions (mm):

Overall: 73x24 Dia.

-  CP
-  PB
-  SC



DK5

**LARGE COVERED
ESCUTCHEON FLUTED**

Dimensions (mm):

Overall: 73x24 Dia.



CP



PB



SC



DK6

**STEPPED OVAL SHAPE
COVERED ESCUTCHEON**

Standard Lock

Dimensions (mm):

Overall: 30x60 Dia.



CP



PB



SC





AQ90

FLUSH PULL

Dimensions (mm):

Overall: 102x45

-  CP
-  PB
-  SC



AA62

**SILENT PATTERN
CABIN HOOK**

Dimensions (mm): 152

Finish: CP/PB/SC





AA63 202

AA64 254

AA65 305

AA60 Lightweight 76

AA61 Lightweight 102

-  CP
-  FB
-  PB
-  SC

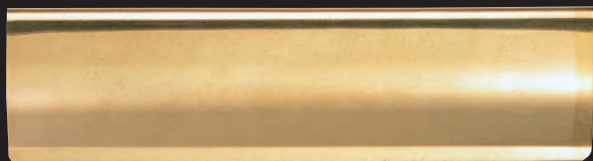

AA53

LETTER TIDY Curved Pattern

Finishes: PB/FB/SS/SSCP

Dimensions (mm):

Overall: 280x76

Finishes: PB/SS/SSCP

AA52 300x95

AA54 Foam Lined 280x76

Finishes: PB/SC/SSCP

AA56 355x127



FB



PB



SC



SS



SSCP



SP104

**SPARE THUMBTURN AND
RELEASE SPINDLE**

5mm Spindle for Bathroom Lock

Dimensions (mm):

Overall Length: 96.5

Spindle: 4.9x67

Finishes: CP/PB/PVD/SC

SP104L

Overall Length: 109.5

Spindle: 4.9x80



CP



FB



PB



PVD



SC



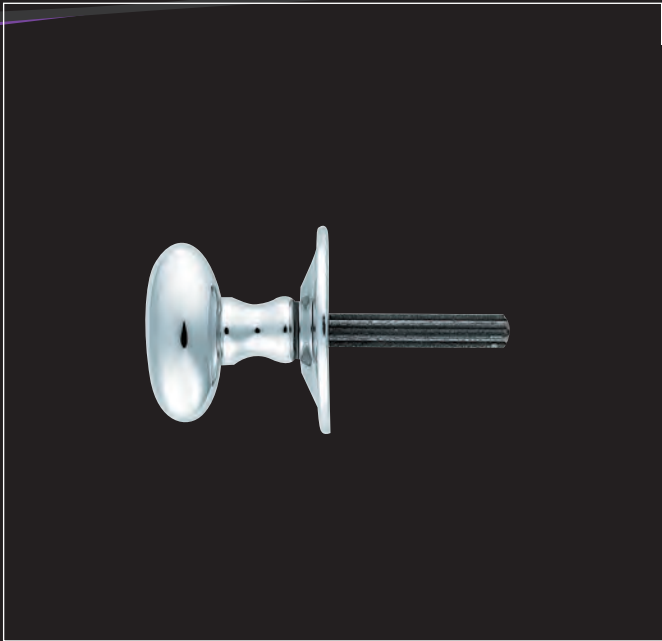





AA33

OVAL THUMBTURN

To Operate Rack Bolt
(Hardened Steel Spindle)

Dimensions (mm):

Rose: 38 Dia.
Knob: 32x20

-  BA
-  CP
-  PB
-  SC

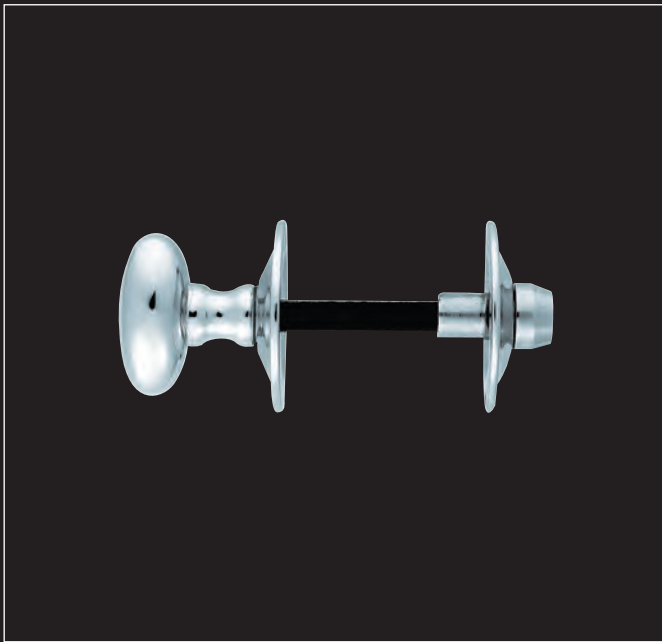





AA133

**OVAL THUMBTURN
WITH COIN RELEASE**

5mm Spindle for Bathroom Lock

Dimensions (mm):

Rose: 32 Dia.
Knob: 32x20

-  BA
-  CP
-  PB
-  SC

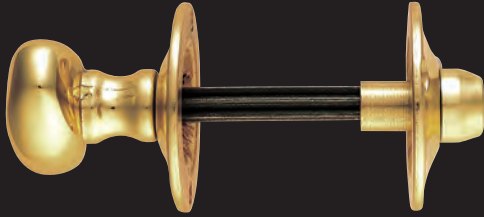

AA32

**OVAL THUMBTURN
WITH COIN RELEASE**

Dimensions (mm):

Rose:	36 Dia.
Knob:	32x20
Spline Spindle:	4.5x45

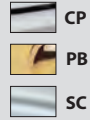



M1002

**QUEEN ANNE FINGER
PLATE****Dimensions (mm):**

Overall: 305x70



PB

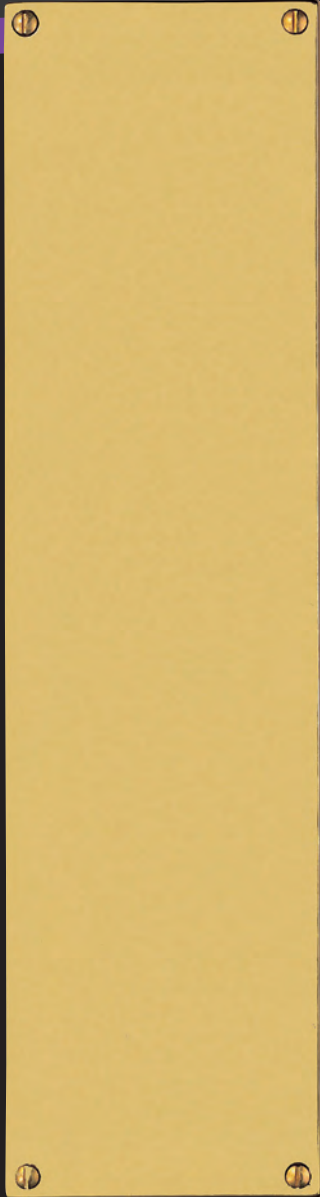

M39F

FINGER PLATE FLAT SHEET

Dimensions (mm):

Overall: 305x76

Plate Thickness: 0.5



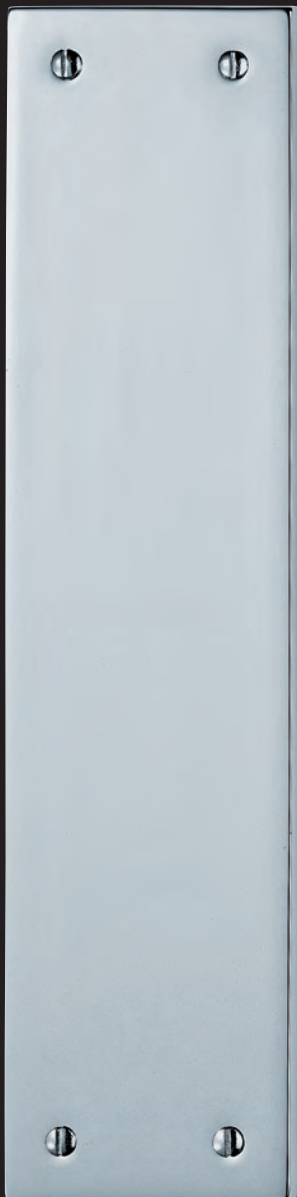

M39

FINGER PLATE

Dimensions (mm):

Overall: 305x70

Plate Thickness: 6



CP



PB



SC





DL20

**FINGER PLATE
SHAPED END**

Dimensions (mm):

Overall: 305x64

Plate Thickness: 10



PB



AA21/23B budget versions
available in PB
Contact our sales office

AA21

**CYLINDER PATTERN
DOOR STOP With Rose**

Dimensions (mm):
Length: 64

Variations:
AA23 76



CP



PB



SC



AA22

**CYLINDER PATTERN
DOOR STOP Without Rose**

Dimensions (mm):
Length: 64

Variations:
AA122 102



CP



PB



SC



AA24

**ROUND FLOOR MOUNTED
DOOR STOP**

Dimensions (mm): 38 Dia.



PB





AA20B budget version
also available
Contact our sales office

AA20

**OVAL FLOOR MOUNTED
DOOR STOP**

Dimensions (mm):

Base: 48x45



CP



PB



SC



DSF3020

**FLOOR MOUNTED
DOOR STOP**

Dimensions (mm): 32 Dia.

Finish: PB

DSF2020

Finish: SC

DSF5020



CP



PB



SC



AA38

**ARCHITECTURAL QUALITY
HAT AND COAT HOOK**

Dimensions (mm):

Projection: 86



CP



PB



AA85

LIGHTWEIGHT HANDRAIL BRACKET

Dimensions (mm):

Height: 64
Projection: 65



CP



PB



SC



AA84

HEAVYWEIGHT HANDRAIL BRACKET

Dimensions (mm):

Height: 64
Projection: 65

Finish: PB
AA86 76



CP



PB



SC



AA26

VICTORIAN ROBE HOOK

Dimensions (mm): 45



CP



PB



SC





AA27

**VICTORIAN DOUBLE
ROBE HOOK**

Dimensions (mm): 51



CP



PB



SC



AA25

HAT AND COAT HOOK

Dimensions (mm):
Overall Height: 127



CP



PB



SC



AQ25

**HEAVY ARCHITECTURAL
QUALITY HAT AND
COAT HOOK**

Dimensions (mm):
Overall Height: 143



CP



PB



SC



FG20

**THUMBTURN AND
RELEASE****Dimensions (mm):** 45 Dia.

PB



FG21

GEORGIAN ESCUTCHEON**Dimensions (mm):** 45 Dia.

PB

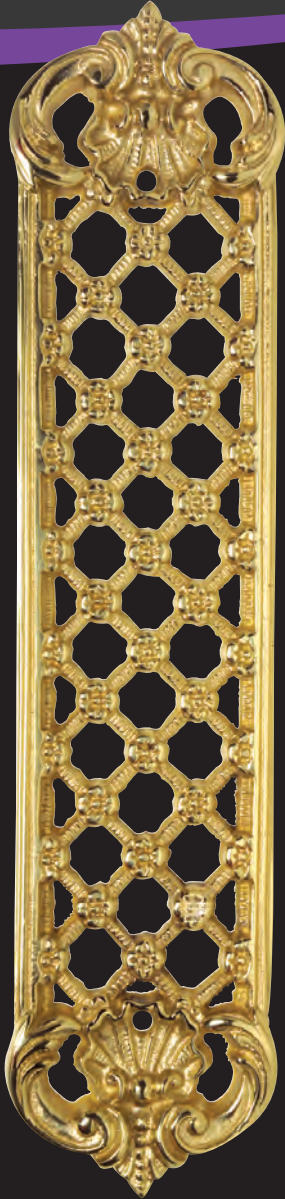

MB3

TRELLIS FINGER PLATE

Dimensions (mm):

Overall: 305x70



PB

For matching pull MB40
see P128



FG10

FINGER PLATE

Dimensions (mm):

Overall: 305x73



PB



MB2

**ART NOUVEAU FINGER
PLATE**

Dimensions (mm):

Overall: 260x76



PB



MB4

CHERUB FINGER PLATE

Dimensions (mm):

Overall: 202x76



PB



MB1

**OLD ENGLISH FINGER
PLATE****Dimensions (mm):**

Overall: 260x70



PB



MB24

**OLD ENGLISH HEAVY
PATTERN HAT AND COAT
HOOK**

Dimensions (mm):

Height: 152



PB



MB28

**OLD ENGLISH HEAVY
PATTERN TREBLE HAT
AND COAT HOOK**

Dimensions (mm):

Height: 152



PB



AA28

HAT AND COAT HOOK

Dimensions (mm):

Height: 127



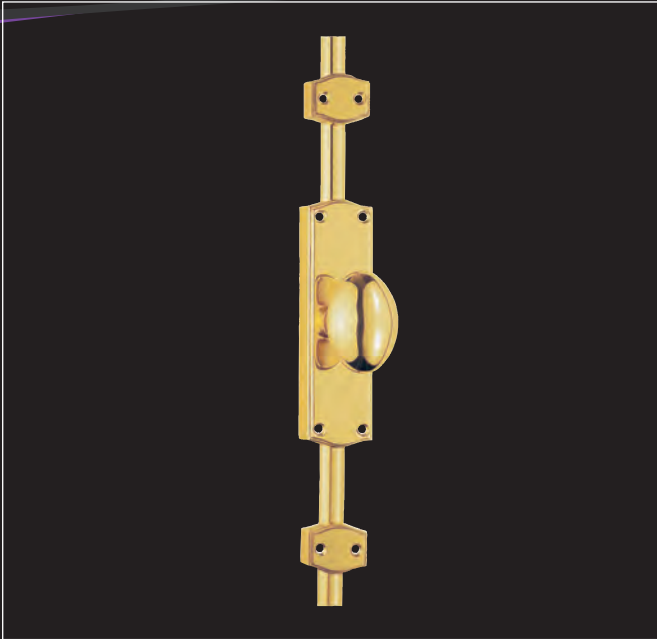

PB



ES34

**ESPAGNOLETTE BOLT
OVAL KNOB SET**

With 2 No. x 1.2m
Rods and Mortice Keepers
c/w Locking Keeper



-  CP
-  PB
-  SC



ES35

**ESPAGNOLETTE BOLT
TEE KNOB SET**

With 2 No. x 1.2m
Rods and Mortice Keepers

-  CP
-  PB
-  SC

- SPARES LIST:**
- | | | |
|---------------|--------------------------------------|--------------|
| SPESES | Spare End Saddles | CP/PB |
| SPESEK | Flat Keeper | |
| SPESEK | Angled Keeper | |
| SPESS | Spare Saddles | |
| SPESTR | Spare Rods | |
| SPESTR | Spare Rods | |
| SPESTR | Spare Rods | |
| SPESTR | Spare Rods Long 1.8m | |
| SPESTR | Fixing Shim for
Espagnolette Bolt | |

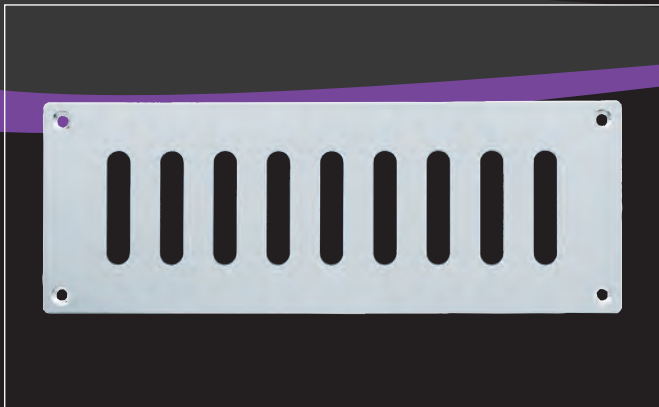

PL4

PLAIN SLOT BRASS VENT

Radius Corners

Dimensions (mm):

Overall: 242x89

Finish: **SSCP**

PL5 242x165

PL6 242x242

Finish: **PB**

PL3 165x89

PL11 600x51

PL12 600x76



PB



SSCP



SSCP

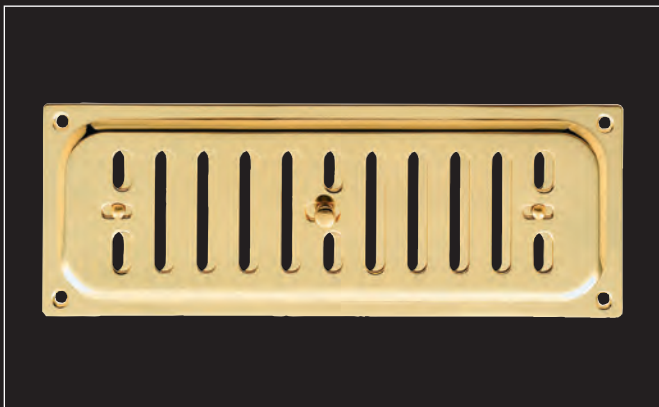

HM4

HIT AND MISS BRASS VENT

Radius Corners

Dimensions (mm):

Overall: 242x89

Variations:

HM5 242x165

HM6 242x242

Finish: **PB/SSCP**

HM3 165x89



PB



SSCP



SSCP



HL4

HOODED LOUVRE BRASS

VENT Radius Corners

Dimensions (mm):

Overall: 242x89

Variations:

HL5 242x165

HL6 242x242

Finish: **PB**

HL3 165x89

HL10 625x76

HL11 600x51



PB



SSCP



SSCP

**AQ1NP****STELLA NARROW PLATE**

Lock Euro

Dimensions (mm):

Backplate: 218x26

Lock Centres: 70

Fixing Centres: 180

Variations:**AQ1NP92**

Lock Centres: 92

Fixing Centres: 123.5

**AQ2NP****STUDIO H NARROW PLATE**

Lock Euro

Dimensions (mm):

Backplate: 220x26

Lock Centres: 70

Fixing Centres: 180

Variations:**AQ2NP92**

Lock Centres: 92

Fixing Centres: 123.5



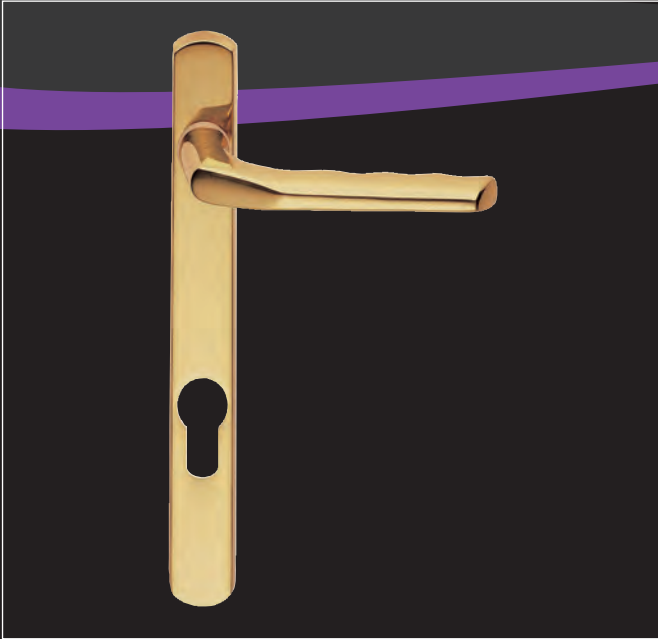

M86NP92

**STRAIGHT NARROW
PLATE** Lock Euro

Dimensions (mm):

Backplate:	218x26
Lock Centres:	92
Fixing Centres:	123.5

Variations: PB

Lock Centres:	70
Fixing Centres:	180



CP



PB



M140NP92RH

SCROLL NARROW PLATE
Lock Euro - Right Hand

Dimensions (mm):

Backplate:	218x26
Lock Centres:	92
Fixing Centres:	123.5

Variations: M140NP92LH Left Hand

Variations: BL/PB
M140NPLH Left Hand

Lock Centres:	70
Fixing Centres:	180

M140NPRH Right Hand

Lock Centres:	70
Fixing Centres:	180



BL



CP



PB

**SZS01NP92****ROSA NARROW PLATE**

Lock Euro

Dimensions (mm):

Backplate: 220x26

Lock Centres: 92

Fixing Centres: 123.5



CP



PVD



SC

**SZS03NP92LH****VERDE NARROW PLATE**

Lock Euro - Left Hand

Dimensions (mm):

Backplate: 220x26

Lock Centres: 92

Fixing Centres: 123.5

Variations:**SZS03NP92RH** Right Hand

Lock Centres: 92

Fixing Centres: 123.5



CP



SC



SZS12NP92LH

AMARILLO NARROW PLATE Lock Euro - Left Hand

Dimensions (mm):

Backplate: 220x26

Lock Centres: 92

Fixing Centres: 123.5

Variations:

SZS12NP92RH Right Hand



CP



SC



AA80

LEVER ACTION FLUSH BOLTS

Dimensions (mm):

Overall: 150x20

Shoot Diameter: 11

Variations:

AA81 202x20

Finishes: CP/PB/SN

AA810 254x20

AA812 305x20

Finishes: CP/PB

AA818 450x20

AA824 600x20



CP



PB



SC



SN





SL2

SLEEVE LETTER PLATE

To suit Doors 35-65mm Thick

Dimensions (mm): **GA**
 Overall: 292x64
 Aperture: 255x38

Finishes:

SL1 **SA**
SL3 **PCW**
SL4 **PCB** *SPECIAL ORDER

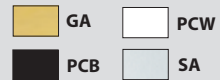

ML110921/24/28

PRO STYLE LETTERBOX

To suit Doors 40-80mm Thick

Dimensions (mm):
 Overall: 310x76
 Aperture: 264x46



AA79

SUNK SLIDE FLUSH BOLT

Dimensions (mm):
 Overall: 102x17
 Shoot Diameter: 8

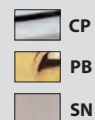

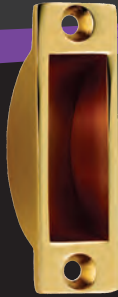

AA813

FLUSH BOLT SOCKET
13mm Slot Size

Dimensions (mm):

Overall: 64x20



CP



PB



SN



AQ46
WOOD



AQ47
CONCRETE

AQ46

DUST EXCLUDING SOCKET FOR FLUSH BOLTS Wood

Dimensions (mm): CP/PB

Circular section: 45 Dia.

Hole Size: 12

AQ47 Concrete

Dimensions (mm): CP/PB/SC

Circular section: 25 Dia.

Hole Size: 12



CP



PB



SC



Aluminium version also available

BR35

BATHROOM INDICATOR BOLT

Dimensions (mm):

Overall: 64x38



CP



PB





AA34

**SECURITY BOLT WITH
TURN**
Dimensions (mm):

Fixing Plate: 57x20



AA35

**INDICATOR BOLT WITH
EMERGENCY RELEASE**
Dimensions (mm):

Fixing Plate: 57x20

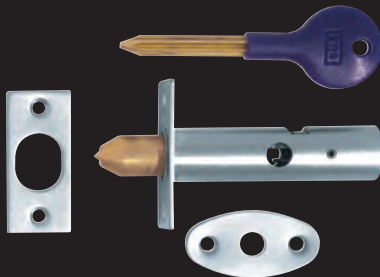

DSB8225

SECURITY DOOR BOLT
Dimensions (mm):

Length: 60

Backset: 32

Variations:
DSB8225L

Length: 85

Backset: 57

DSK8000

Key



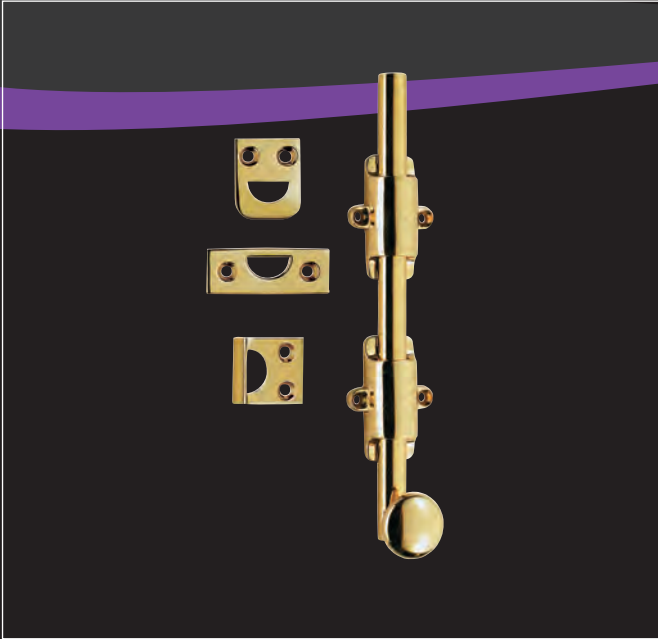

DB8

DUTCH DOOR BOLT

c/w 3 Keepers for Various Applications

Dimensions (mm):

Length: 202

Variations:

DB12 305

DB18 457

DB24 610

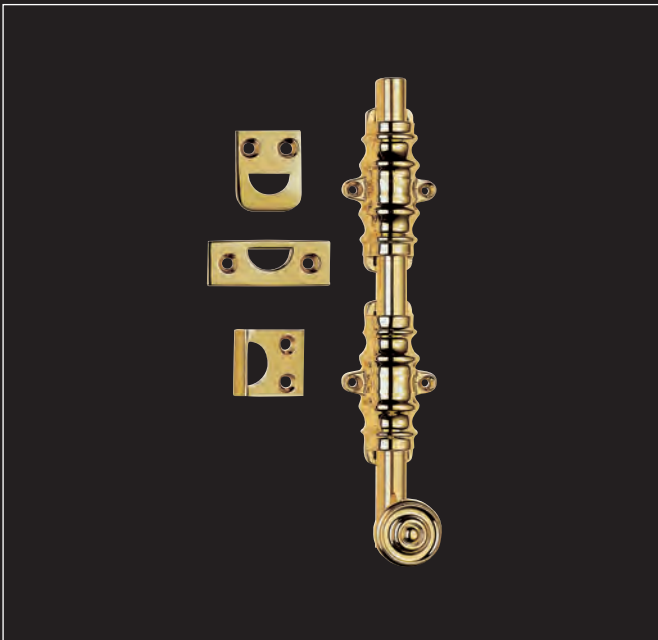
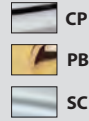

OD8

**ARCHITECTURAL
SURFACE BOLT**

c/w 3 Keepers for Various Applications

Dimensions (mm):

Length: 202

Variations:

OD12 305

Finish: PB

OD18 457

OD24 610



**AQ82EX****SURFACE BOLT**

c/w 3 Keeps for Various Applications

Dimensions (mm):

Extended Bolt: 150
Overall Length: 355

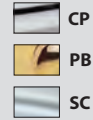
**AQ82****SURFACE BOLT**

c/w 3 Keeps for Various Applications

Dimensions (mm):

Overall: 150x35

Variations:

AQ81 102x35

Finishes:

AQ83 202x35
AQ84 254x35

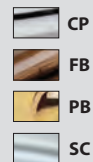

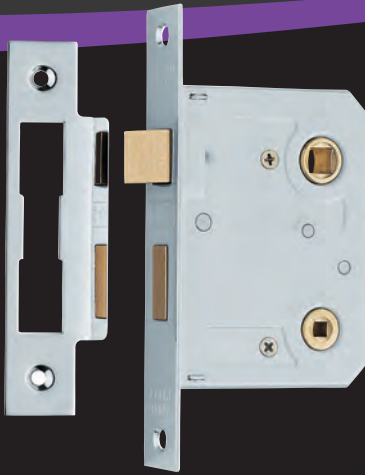

BL4

BATHROOM LOCK

Finish: NP
Dimensions (mm):
 Nickel Plate Forend: 76

Variations:
BL2
 Nickel Plate Forend: 64

Finishes: EB/FB
BL1
 Electro Brass Forend: 64
BL3
 Electro Brass Forend: 76

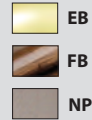

CL155SGVCB

**MECHANICAL DIGITAL
DOOR LOCK**

Dimensions (mm):
 Latch: 60

CL155SGVCB only available
in pre-pack





TL1-4 EB and NP finishes also available in Radius
 TL1 = TLE8025EB/R
 TL2 = TLE8025NP/R
 TL3 = TLE8030EB/R
 TL4 = TLE8030NP/R

TL4

TUBULAR LATCH

Rebate Set TL7A Available

Finish: NP

Dimensions (mm):

Nickel Plate Forend: 76

Variations:

TL2 Tubular Mortice Latch: 64

STL2 Super Latch Extra Spring: 64

STL4 Super Latch Extra Spring: 76

Finishes: EB/FB/PCB

TL1 Electro Brass Forend: 64

TL3 Electro Brass Forend: 76

Finishes: EB

STL1 Super Latch Extra Spring: 64

STL3 Super Latch Extra Spring: 76

 EB

 FB

 NP

 PCB

(B)



c/w radius and square face plates

BTL1

BOLT THROUGH TUBULAR LATCH

Finish: EB

Dimensions (mm):

Electro Brass Forend: 64

Variations:

BTL3

Electro Brass Forend: 76

Finish: NP

BTL2

Nickel Plate Forend: 64

BTL4

Nickel Plate Forend: 76

 EB

 NP

(B)



ART5005 Rebate set
available
38mm Bolt through
centres on DL5030-50

DL5030

**DELAMAIN HEAVY
SPRUNG TUBULAR LATCH**

Dimensions (mm):

Overall Length:	76
Backset:	57

Variations:

DL5025



Overall Length:	64
Backset:	45

DL5040

Overall Length:	103
Backset:	82

DL5050

Overall Length:	128
Backset:	107

-  **FB**
-  **PB**
-  **SS**

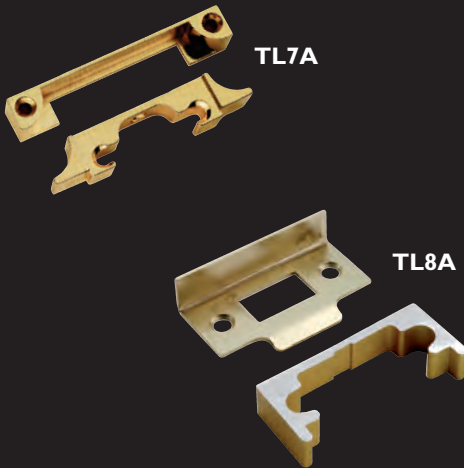

TL7A REBATE SET

To Suit Tubular Latches

Dimensions (mm):

Strike:	13x22
Length:	92

TL8A SUPER REBATE SET

To Suit Tubular Latches

Dimensions (mm):

Strike:	13x25
Length:	57

TL9A REBATE SET

To Suit Tubular Latches

Dimensions (mm):

Strike:	13x22
Length:	92

-  **EB**
-  **NP**





38mm Bolt through centres

DLD5030

DEAD BOLT

Dimensions (mm):

Overall Length:	76
Backset:	57

Variations:

DLD5040

Overall Length:	103
Backset:	82

DLD5050

Overall Length:	128
Backset:	107

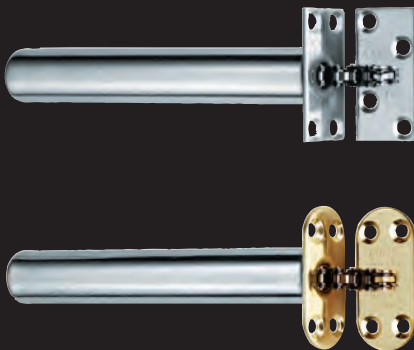
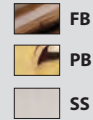

AA45

CONCEALED CHAIN SPRING DOOR CLOSER

FIRE TEST CERTIFICATE
BS476:PART 22:1987

Dimensions (mm):

Forend:	45
---------	----

Variations:

AA45R	Radius
-------	--------

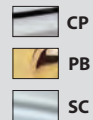





AA46

EASI-KEEP LATCH
FIRE TEST CERTIFICATE
BS476:PART 22:1987

Dimensions (mm):

Overall Size: 63x40
Depth: 10

-  CP
-  EB
-  PCW

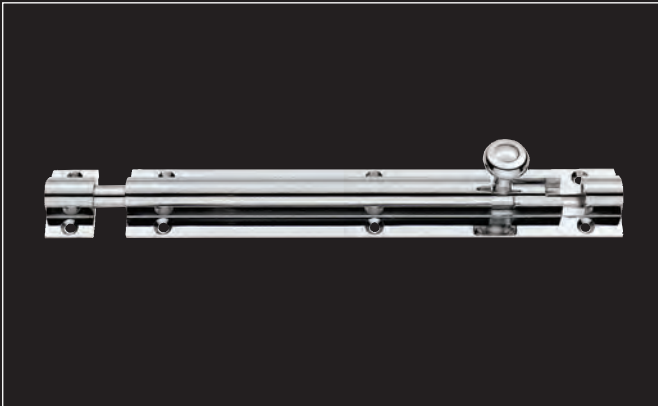

BB3208

BARREL BOLT





Dimensions (mm):

8"x32

Variations:

- BB3204** 4"x32
- BB3206** 6"x32
- BB3806** 6"x38
- BB3808** 8"x38
- BB3810** 10"x38
- BB3812** 12"x38
- BB4512** 12"x45
- BB4518** 18"x45

-  CP
-  PB
-  SC





DK45

GRAVITY DOOR CATCH

Dimensions (mm):

Backplate: 30x50

-  CP
-  PB
-  SC

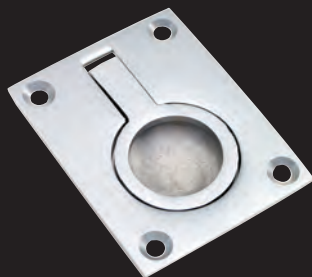
**FRP50****FLUSH RING PULL****Dimensions (mm):**

Overall: 38x50

Variations:**FRP63** 50x63

CP



PB

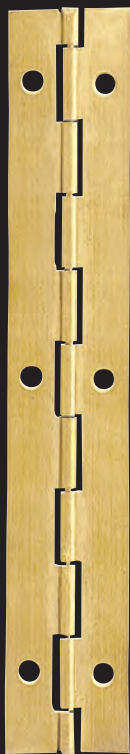

SC

**PBH1****SOLID BRASS
PIANO HINGE****Dimensions (mm):** **PB**
1829x25**Variations:**
PBH2 1829x32**Finish:** **EB**
EBH1 1829x25
EBH2 1829x32
EBH3 1829x38**Finish:** **FB**
FBH1 1829x25
FBH2 1829x32**Finish:** **NP**
NPH1 1829x25
NPH2 1829x32
NPH3 1829x38ALL PIANO HINGES
AVAILABLE IN MULTIPLES
OF 50 ONLY

EB



















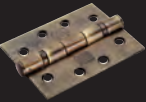

















FB























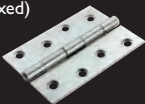
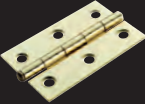

NP



PB

	FINISH	CODE	DESCRIPTION	SIZE
Grade 13 CE Marked  	 BEP	HDBB4	 Grade 13 Double Ball Bearing Hinge c/w screws No. 10x32mm	102x76x3
	 EB  FB			
Double Ball Bearing 	 P/L	HDBB1	 Double Ball Bearing Hinge c/w screws No.10x32mm	101x76x3
		HDBB3	 Double Ball Bearing Hinge c/w screws No. 10x32mm	76x50x2
Double Stainless Steel Washered 	 CP	HDSSW2	 Double Stainless Steel Washered Brass Butt Hinge	76x50x2.5
	 SC	HDSSW5	 Double Stainless Steel Washered Brass Butt Hinge	102x67x4
Double Steel Washered 	 CP	HDSW1	 Double Steel Washered Brass Butt Hinge c/w screws No. 8x32mm	76x50x2
	 P/L	HDSW2	 Double Steel Washered Brass Butt Hinge c/w screws No. 10x40mm	102x67x2.2
	 SB	HDSW20	 Double Steel Washered Brass Butt Hinge	76x50x2.5
		HDSW3	Double Steel Washered Brass Butt Hinge	102x67x2.5
	 P/L	HDSW4	Double Steel Washered Brass Butt Hinge	102x67x2.5
	 SB	HDSW9	Double Steel Washered Brass Butt Hinge	127x76x3
Double Phosphor Bronze Washered 	 FB	HDPBW21	 Double Phosphor Bronze Washered Butt Hinge	76x50x2.5
	 P/L		FB c/w screws	
	 P/L	HDPBW4	 Double Phosphor Bronze Washered Butt Hinge	102x67x2.5
	 FB	HDPBW61	 Double Phosphor Bronze Washered Butt Hinge (Lacquered)	102x67x4
	 P/L		FB c/w screws	
	 P/L	HDPBW8	Double Phosphor Bronze Washered Butt Hinge	102x76x4
		HDPBW10	Double Phosphor Bronze Washered Butt Hinge	127x76x3

	FINISH	CODE	DESCRIPTION	SIZE
Solid Drawn 	 SB	HSD3	Solid Drawn Brass Butt Hinge	70x40x1.5
		HSD35	Solid Drawn Brass Butt Hinge	76x40x2
		HSD4	Solid Drawn Brass Butt Hinge	102x60x2
Fixed Pin 	 EB	HINFP1	 Fixed Pin Hinge	76x50
	 PCB	HINFP4	 Fixed Pin Hinge	102x67
Loose Pin 	 CP	HINLP1	 Loose Pin Hinge c/w screws pozi drive W c/w screws No. 7x32mm pozi drive	76x50
	 EB			
	 W			
	 CP	HINLP4	 Loose Pin Hinge CP c/w screws	102x67
 EB				
Contractors Range (Boxed)  	 EB	183876	Narrow Pattern Butt Hinge	76x20
	 SCOL	1838100	Narrow Pattern Butt Hinge	102x30
	 ZP			
	 EB	184076	Narrow Pattern Loose Pin Butt Hinge	76x20
	 SCOL			
	Spare Screws	 CP	SCP10	Counter Sunk Headed Pozi Screw Brass
		SCP8	Counter Sunk Headed Pozi Screw Electro Brass	No. 8x26
 EB		SEB7	Counter Sunk Headed Pozi Screw Electro Brass	No. 7x26
 PB		SPB10	Counter Sunk Headed Pozi Screw Polished Brass	No. 10x30

Also available in hanging bags - A full range of hinges for the building trade. Flush, rising butt, 1838, 451 strong, security, loose pin and parliament.



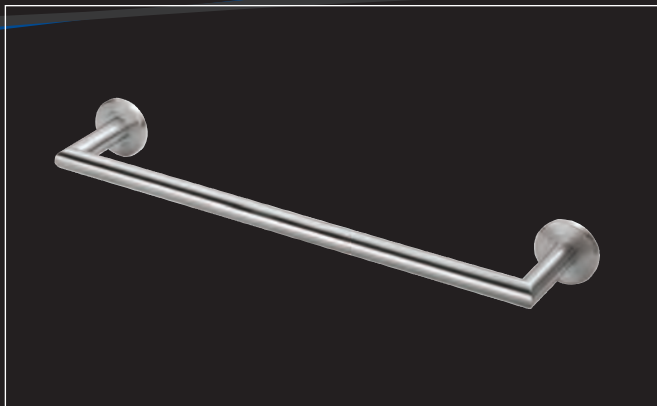

LX21

SINGLE TOWEL RAIL

Dimensions (mm):

Width:	448
Height:	50
Projection:	85

Variations:

LX22

Width:	645
--------	-----

LX23

Width:	848
--------	-----



SS



LX25

GLASS SHELF

Dimensions (mm):

Width:	647
Height:	50
Projection:	125



SS

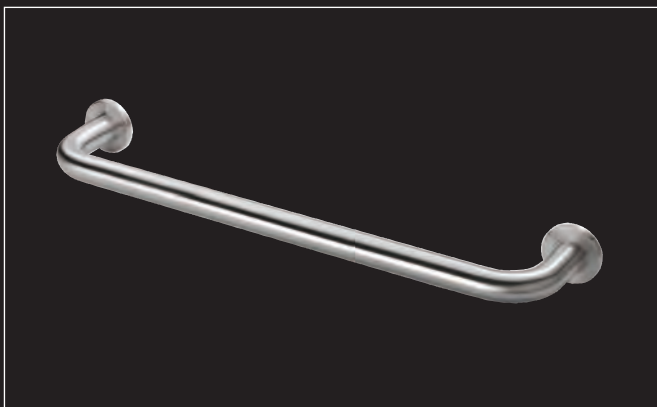

LX04

GRAB RAIL

Dimensions (mm):

Width:	498
Height:	50
Projection:	102



SS



LX07

PAPER HOLDER**Dimensions (mm):**

Width:	150
Height:	50
Projection:	90



SS



LX12

SINGLE TUMBLER HOLDER**Dimensions (mm):**

Width:	63
Height:	140
Projection:	90



SS



LX13

SOAP DISH**Dimensions (mm):**

Width:	110
Height:	60
Projection:	125



SS



LX14

**TOILET BRUSH AND
HOLDER**

Dimensions (mm):

Width:	78
Height:	236
Projection:	100



LX05

TOWEL RING

Dimensions (mm):

Width:	270
Height:	280
Projection:	90





LX03

ROBE HOOK**Dimensions (mm):**

Width:	50
Height:	54
Projection:	44



SS

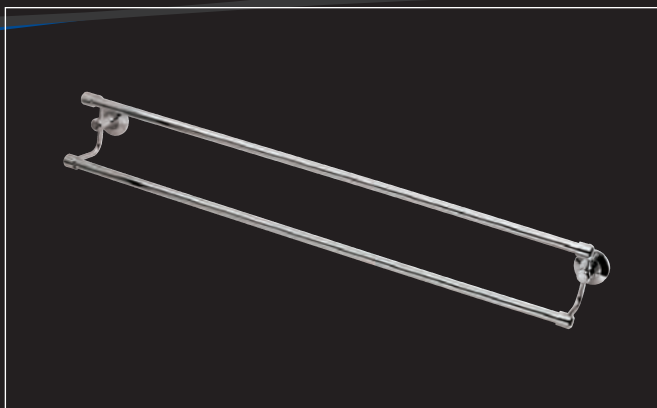

LW18

DOUBLE TOWEL RAIL

Dimensions (mm):

Width:	510
Height:	110
Projection:	110

Variations:

LW19

Width:	660
--------	-----

LW20

Width:	806
--------	-----



CP

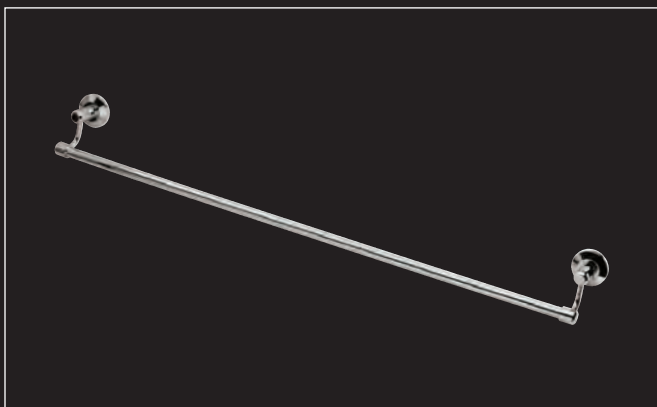

LW21

SINGLE TOWEL RAIL

Dimensions (mm):

Width:	522
Height:	80
Projection:	90

Variations:

LW22

Width:	672
--------	-----

LW23

Width:	825
--------	-----



CP

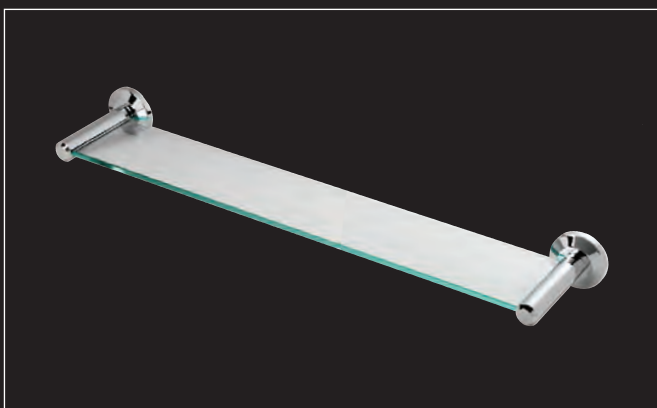

LW24

GLASS SHELF

Dimensions (mm):

Width:	490
Height:	50
Projection:	120

Variations:

LW25

Width:	667
--------	-----

LW26

Width:	817
--------	-----



CP



LW07

PAPER HOLDER**Dimensions (mm):**

Width:	180
Height:	120
Projection:	50



CP



Spare parts available on request

LW12

SINGLE TUMBLER HOLDER**Dimensions (mm):**

Width:	76
Height:	103
Projection:	150



CP



Spare parts available on request

LW13

SOAP DISH AND HOLDER**Dimensions (mm):**

Width:	110
Height:	90
Projection:	165



CP



LW14

**TOILET BRUSH AND
HOLDER**

Dimensions (mm):

Width:	95
Height:	375
Projection:	172



CP



LW05

TOWEL RING

Dimensions (mm):

Width:	180
Height:	245
Projection:	92



CP



LW02

DOUBLE ROBE HOOK**Dimensions (mm):**

Width:	54
Height:	55
Projection:	53



CP



LW09

TOOTHBRUSH HOLDER**Dimensions (mm):**

Width:	76
Height:	80
Projection:	150



CP



LW08

SPARE PAPER HOLDER**Dimensions (mm):**

Width:	80
Height:	168
Projection:	92



CP

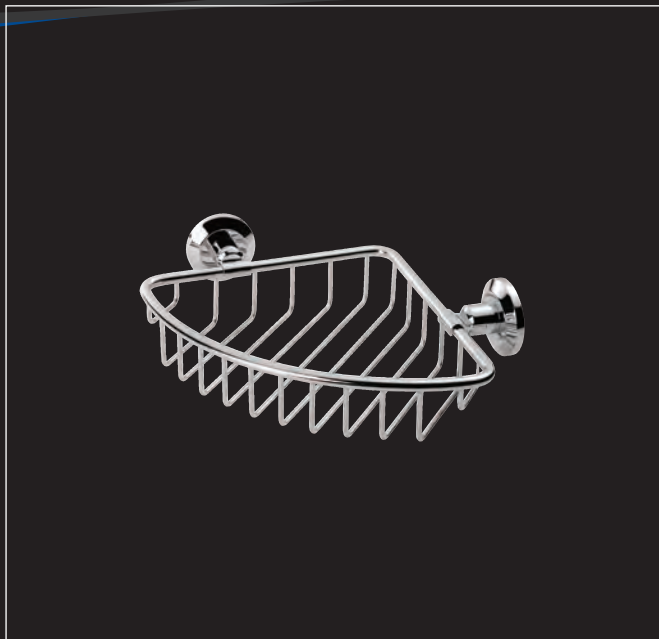

LW17

TRIANGULAR SOAP TRAY

Dimensions (mm):

Width:	197
Height:	83
Projection:	216



LW29

OVAL MIRROR

Dimensions (mm):

Width:	400
Height:	498
Projection:	12





LW27

LIQUID SOAP DISPENSER**Dimensions (mm):**

Width:	78
Height:	187
Projection:	168



CP

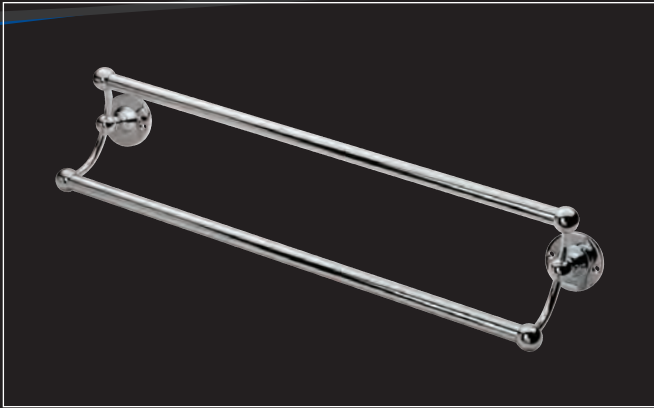

LE18

DOUBLE TOWEL RAIL

Width: 525
Height: 125
Projection: 105

Variations:

LE19

Width: 665

LE20

Width: 820

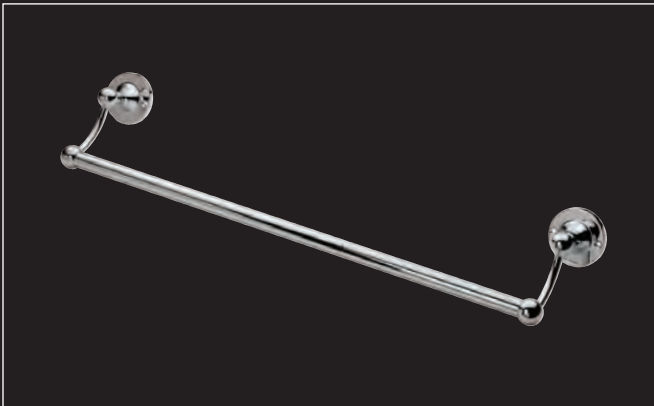

LE21

SINGLE TOWEL RAIL

Dimensions (mm):

Width: 465
Height: 125
Projection: 105

Variations:

LE22

Width: 670

LE23

Width: 820

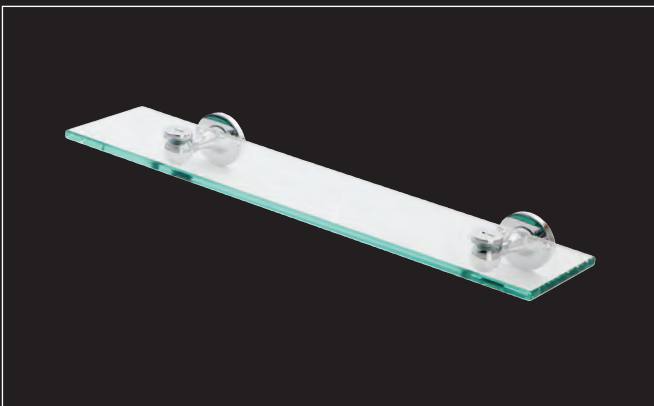

LE24

GLASS SHELF

Dimensions (mm):

Width: 460
Height: 52
Projection: 122

Variations:

LE25

Width: 610

LE26

Width: 760



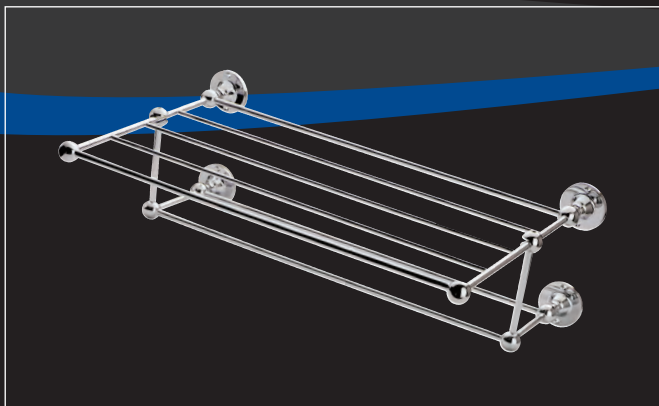

LE28

OVERHEAD TOWEL RACK**Dimensions (mm):**

Width:	730
Height:	165
Projection:	300

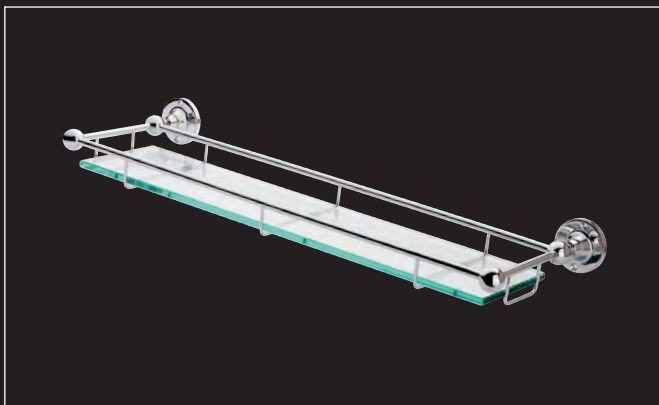

LE30

GALLERY RAIL GLASS SHELF**Dimensions (mm):**

Width:	560
Height:	60
Projection:	105



LE04

GRAB RAIL**Dimensions (mm):**

Width:	513
Height:	70
Projection:	63



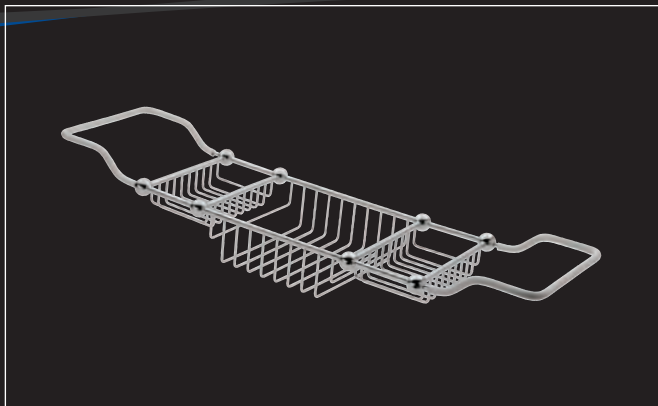

LE01

BATH RACK

Extendable

Dimensions (mm):

Width: 192

Height: 100

Projection: 745-815



LE02

DOUBLE ROBE HOOK

Dimensions (mm):

Width: 85

Height: 52

Projection: 70

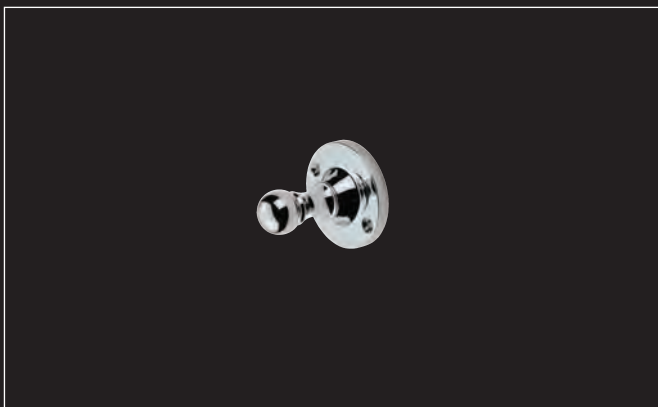

LE03

SINGLE ROBE HOOK

Dimensions (mm):

Width: 52

Height: 52

Projection: 55





LE05

TOWEL RING**Dimensions (mm):**

Width:	170
Height:	195
Projection:	65



CP



LE07

PAPER HOLDER**Dimensions (mm):**

Width:	180
Height:	120
Projection:	68



CP



LE08

SPARE PAPER HOLDER**Dimensions (mm):**

Width:	70
Height:	185
Projection:	102



CP



Spare tumblers LE11C
available

LE12

SINGLE TUMBLER HOLDER

Dimensions (mm):

Width:	80
Height:	115
Projection:	127



Spare tumblers LE11C
available

LE11

DOUBLE TUMBLER HOLDER

Dimensions (mm):

Width:	177
Height:	110
Projection:	145



Spare soap dishes LE13C
available

LE13

SOAP DISH AND HOLDER

Dimensions (mm):

Width:	156
Height:	55
Projection:	165





Spare toothbrush pots
LE09C available

LE09

TOOTHBRUSH HOLDER**Dimensions (mm):**

Width:	105
Height:	106
Projection:	87



LE06

PILLAR PAPER HOLDER**Dimensions (mm):**

Width:	210
Height:	52
Projection:	80



LE31

DOG BONE PAPER HOLDER**Dimensions (mm):**

Width:	207
Height:	51
Projection:	82





LE16

SHOWER SOAP DISH

Dimensions (mm):

Width:	195
Height:	65
Projection:	130



CP

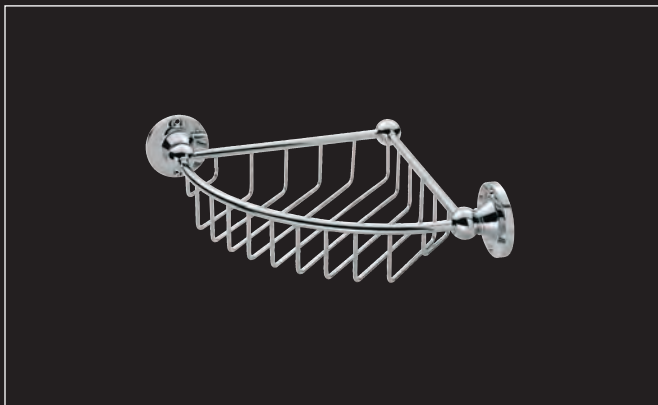

LE17

TRIANGULAR TRAY

Dimensions (mm):

Width:	230
Height:	70
Projection:	230



CP

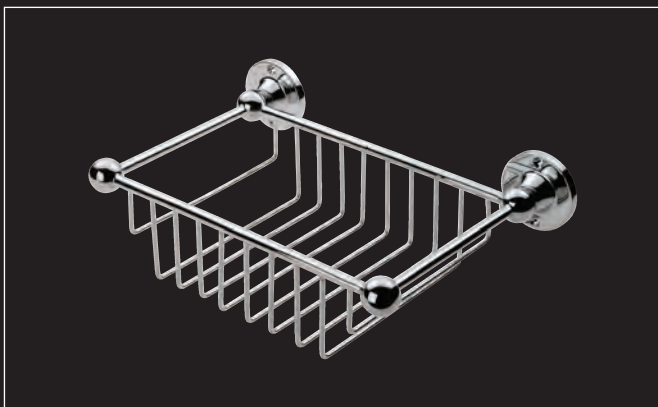

LE15

SPONGE HOLDER

Dimensions (mm):

Width:	280
Height:	90
Projection:	180



CP



LE14

**TOILET BRUSH AND
HOLDER****Dimensions (mm):**

Width: 110

Height: 415

Projection: 160



CP

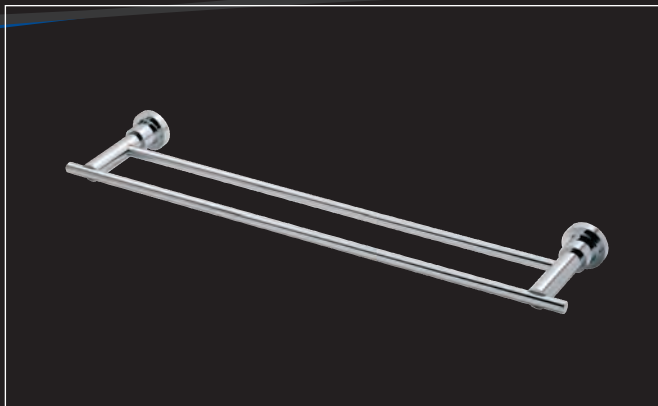

LV19

DOUBLE TOWEL RAIL

Dimensions (mm):

Width:	600
Height:	48
Projection:	120

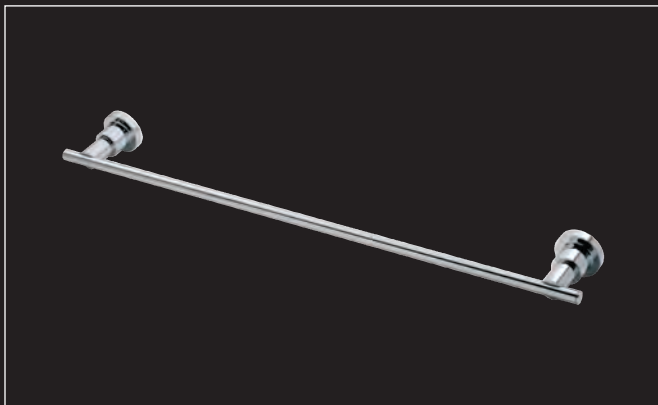

LV22

SINGLE TOWEL RAIL

Dimensions (mm):

Width:	600
Height:	48
Projection:	72

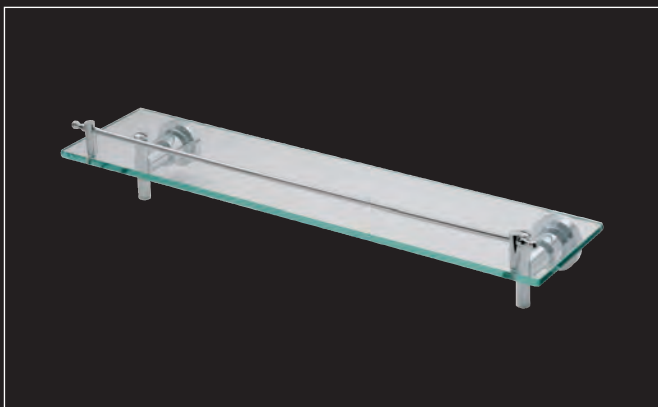

LV24

GLASS SHELF

Dimensions (mm):

Width:	520
Height:	100
Projection:	130





LV02

ROBE HOOK**Dimensions (mm):**

Width:	48
Height:	70
Projection:	70



LV05

TOWEL BAR**Dimensions (mm):**

Width:	220
Height:	48
Projection:	70



LV07

PAPER HOLDER**Dimensions (mm):**

Width:	170
Height:	48
Projection:	70





LV12

SINGLE TUMBLER HOLDER

Dimensions (mm):

Width:	125
Height:	95
Projection:	70



CP



LV11

DOUBLE TUMBLER HOLDER

Dimensions (mm):

Width:	75
Height:	93
Projection:	98



CP



LV13

SOAP DISH AND HOLDER

Dimensions (mm):

Width:	145
Height:	52
Projection:	120



CP



LV14

**TOILET BRUSH AND
HOLDER****Dimensions (mm):**

Width: 170

Height: 380

Projection: 122



CP

**LF56NP92****STRAIGHT
NARROW PLATE****Dimensions (mm):**

Backplate:	218x30
Lever Length:	119
Projection:	60
Centres:	92



BA

**LF5505****FLEUR DE LYS** Latch**Dimensions (mm):**

Backplate:	210x57
Lever Length:	101
Projection:	53

Variations:

LF5504	Lock
LF5506	Bathroom



BA



B



LF5502

TRADITIONAL Latch

Dimensions (mm):

Backplate: 155x55

Lever Length: 95

Projection: 68

Variations:

LF5501 Lock

LF5503 Bathroom

LF5501Y Lock Euro 47.5c/c



BA



B



LF5518

TRADITIONAL V Bathroom

Dimensions (mm):

Backplate: 155x55

Lever Length: 101

Projection: 50

Variations:

LF5516 Lock

LF5517 Latch



BA



B

**LF5507Y**

SLIMLINE V Lock Euro
47.5 c/c

Dimensions (mm):

Backplate:	158x38
Lever Length:	101
Projection:	57

Variations:

LF5507	Lock
LF5508	Latch
LF5509	Bathroom



BA

B

**LF5116**

CURLY TAIL Lock

Dimensions (mm):

Backplate:	170x52
Lever Length:	123
Projection:	55

Variations:

LF5117	Latch
LF5118	Bathroom



BA



LF5111

**CURLY TAIL ON GOTHIC
BACKPLATE** Latch

Dimensions (mm):

Backplate:	222x50
Lever Length:	123
Projection:	50

Variations:

LF5110	Lock
LF5112	Bathroom



BA



LF5114

**BARLEY TWIST ON
GOTHIC BACKPLATE** Latch

Dimensions (mm):

Backplate:	222x50
Lever Length:	116
Projection:	64

Variations:

LF5113	Lock
LF5115	Bathroom



BA



LF5594

BALL MORTICE KNOB

Unsprung

Dimensions (mm):

Rose: 60 Dia.

Knob: 45 Dia.

Projection: 67



LF5595

OVAL MORTICE KNOB

Unsprung

Dimensions (mm):

Rose: 60 Dia.

Knob: 64x36

Projection: 60



LF5550

**OCTAGONAL CENTRE
DOOR KNOB****Dimensions (mm):**

Rose: 63 Dia.

Knob: 62 Dia.

Projection: 63





LF5533Y

**EURO SHIELD
ESCUTCHEON**

Dimensions (mm):

Overall: 60x38



BA



LF5539U

**STANDARD PROFILE ON
OVAL SHAPE ESCUTCHEON**

Dimensions (mm):

Overall: 34x51



BA



LF5546

**STANDARD COVERED
ESCUTCHEON**

Dimensions (mm): 40 Dia.



BA





LF5539

EURO ESCUTCHEON**Dimensions (mm):** 52 Dia.

LF5532

**FLEUR DE LYS
ESCUTCHEON****Dimensions (mm):**
Overall: 84x25

LF5533

**SHIELD COVERED
ESCUTCHEON****Dimensions (mm):**
Overall: 58x31



LF5531

FLORAL ESCUTCHEON

Dimensions (mm):

Overall: 48x32



BA



LF5538

**PLAQUE COVERED
ESCUTCHEON**

Dimensions (mm):

Overall: 45x29



BA





LF5525

**FLEUR DE LYS
LETTER PLATE****Dimensions (mm):**

Overall: 365x90

Aperture: 195x45

Fixing Centres: 250



BA



LF5524

**TRADITIONAL LETTER
PLATE****Dimensions (mm):**

Overall: 265x90

Aperture: 195x45

Fixing Centres: 230



BA



AA55BA

LETTER TIDY**Dimensions (mm):**

Overall: 297x80



BA





LF5523

**LETTER PLATE WITH
KNOCKER**

Dimensions (mm):

Overall: 375x130

Aperture: 195x45

Fixing Centres: 230

Length Excluding Finials: 260



 BA

LF5543

**FLEUR DE LYS RIM
CYLINDER PULL**

Dimensions (mm):

Overall: 144x63



 BA

B



LF5534

FLEUR DE LYS BELL PUSH

Dimensions (mm):

Overall: 120x30



BA



LF5536

DOOR CHAIN

Dimensions (mm):

Overall: 135x85



BA





LF5591

ORNATE DOOR KNOCKER

Dimensions (mm):

Overall: 212x80



BA



LF5592

DOOR KNOCKER

Dimensions (mm):

Overall: 200x80



BA



LF5549-5

NUMERAL Face Fix**Dimensions (mm):**

Height: 76

Variations:

LF5549-0	Numeral 0
LF5549-1	Numeral 1
LF5549-2	Numeral 2
LF5549-3	Numeral 3
LF5549-4	Numeral 4
LF5549-6	Numeral 6 or 9
LF5549-7	Numeral 7
LF5549-8	Numeral 8



BA

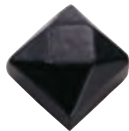

LF55102

DOOR STUD**Dimensions (mm):** 15 sq.

BA



LF55103

DOOR STUD LARGE**Dimensions (mm):** 23 sq.

BA





LF5590

RING DOOR KNOCKER

Dimensions (mm):

Ring: 95 Outer Dia.



BA



B



LF5544A

8" BULB END CASEMENT STAY**Dimensions (mm):**

Length: 203

Variations:

LF5544B 10" (254)

LF5544C 12" (305)



BA



LF5545

BULB END CASEMENT FASTENER

Not Suitable for Weather Stripped Windows

Dimensions (mm):

Backplate: 58x24



BA





LF1006LH

**LOCKING CASEMENT
FASTENER** Left Hand
Not Suitable for Weather
Stripped Windows

Dimensions (mm):

Backplate: 57x17

Variations:

LF1006RH Right Hand



BA



LF34LH

**LOCKING ESPAGNOLETTE
FASTENER** Left Hand
Suitable for Weather
Stripped Windows

Dimensions (mm):

Backplate: 58x24

Variations:

LF34RH Right Hand



BA



LF5537

CASEMENT FASTENER

Not Suitable for Weather Stripped Windows

Dimensions (mm):

Backplate: 60x23



BA



LF5540A

CASEMENT STAY**Dimensions (mm):**

Length: 203

Variations:

LF5540B 254

LF5540C 305



BA





LF5542

**CURLY TAIL CASEMENT
FASTENER**

Not Suitable for Weather
Stripped Windows

Dimensions (mm):

Overall Length: 124

Width: 80



BA

B



LF5541A

**CURLY TAIL CASEMENT
STAY**

Dimensions (mm):

Length: 203

Variations:

LF5541B 254

LF5541C 305



BA

B



LF5101

**BARLEY TWIST PULL
HANDLE ON BACKPLATE****Dimensions (mm):**

Backplate: 310x65

Projection: 72



BA



LF5103

**ARMORIAL PULL HANDLE
ON BACKPLATE**

Dimensions (mm):

Backplate: 310x65

Projection: 72

Overall Length: 406



BA



LF5260LH

**ARMORIAL PULL HANDLE
ON BACKPLATE** Left Hand**Dimensions (mm):** 260x45**Variations:****LF5260RH** Right Hand

BA



LF5575A

4" HOTBED HANDLE**Dimensions (mm):**

Length: 130

Variations:**LF5575B** 6" (152)

BA



LF5266

**OFFSET PULL HANDLE
ON ROSE**

Dimensions (mm):

Length: 238



BA



LF5574A

PULL HANDLE

Dimensions (mm):

Length: 135

Variations:

LF5574B 180

LF5574C 235



BA





LF55101

FINGER PLATE**Dimensions (mm):**

Overall: 315x65



BA



LF5102

ARMORIAL FINGER PLATE

Dimensions (mm):

Overall: 310x65



BA



LF5535

THUMB LATCH SET**Dimensions (mm):**

Handle:	200
Latch:	140



BA

B



LF5526

HAT AND COAT HOOK**Dimensions (mm):**

145



BA

B



LF5530A

STRAIGHT DOOR BOLT

c/w staple and plate

Dimensions (mm):

Length: 110

Variations:

LF5530B 145

LF5530C 195



BA



LF5563A

CRANKED DOOR BOLT

Dimensions (mm):

Length: 120

Variations:

LF5563B 155

LF5563C 210



BA



LF5528C

8" CABIN HOOK

Dimensions (mm):

Length: 203

Variations:

LF5528A 4" (102)

LF5528B 6" (152)

LF5528D 12" (305)



BA



AA133BA

**OVAL THUMBTURN WITH
COIN RELEASE****Dimensions (mm):**

Rose: 38 Dia.

Spindle: 4.9



BA



AA33BA

OVAL THUMBTURNSplined spindle to operate
rack bolt**Dimensions (mm):**

Rose: 38 Dia.



BA



LF5527

SINGLE WARDROBE HOOK**Dimensions (mm):** 60

BA





LF5130

PROJECTION DOOR STOP

Dimensions (mm):

Height: 75



BA



HINFP1PCB

HINGE FIXED PIN

c/w Screws

Dimensions (mm):

Overall: 76x51

Variations:

HINFP4PCB 102x67



BA



LF5522

HINGE FRONT

Dimensions (mm):

Overall: 305x62

Variations:

LF5521 406x112



BA



LF5515A

TEE HINGE**Dimensions (mm):**

Overall: 380x102

Variations:

LF5515 275x102

LF5515B 430x102



BA



LF5121

SWORD HINGE FRONT**Dimensions (mm):**

Overall: 305x137

Variations:

LF5122 380x145

LF5123 458x155



BA



LF5519A

12" SWORD HINGE**Dimensions (mm):**

Length: 305

Variations:

LF5519B 15" (381)

LF5519C 18" (457)



BA



LF5548

8" SUFFOLK LATCH

Dimensions (mm):

Length: 203

Back of handle to end of
lever approx 80mm



BA



LF5547

**6" RING HANDLE GATE
LATCH****Dimensions (mm):**

Length: 152



BA

H3N1102/13





Grade 13 Triple Knuckle Hinge

Dimensions

Length: 100mm
Width: 88mm
Thickness: 3mm
Maximum Loading: 120kg

Variations

H3N1102/13/R - Radius

-  **BZP**
-  **EB**
-  **PC**
-  **SZP**

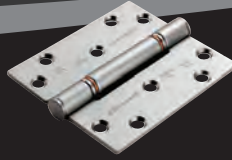





H3N1102A/13

Grade 13 Triple Knuckle Projection Hinge

Dimensions

Length: 100mm
Width: 106mm
Thickness: 3mm
Maximum Loading: 120kg

-  **BZP**
-  **EB**
-  **PC**
-  **SZP**



H3N1101/11/R/LEF





Grade 11 Lift Off (Full Leaf) Hinge - Radius

Dimensions

Length: 100mm
Width: 88mm
Thickness: 3mm
Maximum Loading: 80kg

Variations

H3N1101/11/R/RIG - Right Hand

-  **BZP**
-  **EB**
-  **PC**
-  **SZP**

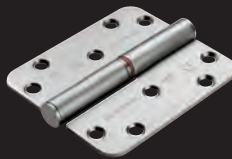

H3N1105/11/R/LEF





Grade 11 Lift Off (Journal Support) Hinge - Radius

Dimensions

Length: 98mm
Width: 82mm
Thickness: 3mm
Maximum Loading: 80kg

Variations

H3N1105/11/R/RIG - Right Hand

-  **BZP**
-  **EB**
-  **PC**
-  **SZP**

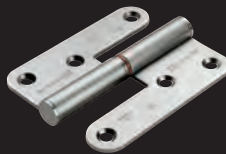

NOTES:

H3N Hinges are supplied in pairs c/w screws and have been assessed as maintenance free. Contact technical for further details.

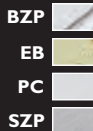

H3N1 107/13/R/LEF

Grade 13 Lift Off (Journal Support) Hinge - Radius

Dimensions

Length: 110mm
Width: 98mm
Thickness: 3.5mm
Maximum Loading: 120kg

Variations

H3N1 107/13/R/RIG - Right Hand

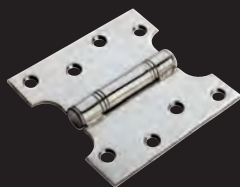

H2N1 424

Grade 13 Parliament Hinge

Dimensions

Length: 102mm
Projection: 50mm
Width: 102mm
Thickness: 3mm

Variations

H2N1 435 - 102x75x127x3.5mm

H2N1 446 - 102x100x152x3.5mm



H2N1 900

Standard Thrust Bearing Pivot Set

Suitable for doors up to 80Kg

Variations

H2N1 900/R - Radius



H2N1 950

Emergency Release Door Stop

Dimensions

Length: 80mm
Width: 40mm

NOTES:

Intumescent hinge liners available. Call sales for details.
All Enduromax hinges tested to and passed BS EN 1935:2002.

H2N11015/13

Grade 13 Thrust Bearing Hinge
Non Removable Pin

Dimensions

Length: 100mm
Width: 100mm
Thickness: 3mm
Maximum Loading: 120kg

Variations

H2N11015/13/R - Radius

H2N1102/13

Grade 13 Thrust Bearing Hinge
Non Removable Pin

Dimensions

Length: 100mm
Width: 89mm
Thickness: 3mm
Maximum Loading: 120kg

Variations

H2N1102/13/R - Radius

H2N1103/13

Grade 13 Thrust Bearing Hinge
Non Removable Pin

Dimensions

Length: 100mm
Width: 76mm
Thickness: 3mm
Maximum Loading: 120kg

Variations

H2N1103/13/R - Radius

H2N1121/14

Grade 14 Thrust Bearing Hinge
Non Removable Pin

Dimensions

Length: 125mm
Width: 102mm
Thickness: 3.5mm
Maximum Loading: 160kg

Variations

H2N1121/14/R - Radius

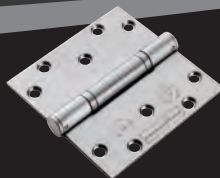

NOTES:

Enduromax are a superior range of maintenance free hinges tested to 500,000 cycles using a unique patented design.

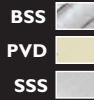

H2N1 202/11/R

**Grade 11 Lift Off
Thrust Bearing Hinge - Radius**

Dimensions

Length: 100mm
Width: 89mm
Thickness: 3mm
Maximum Loading: 80kg

Available in left or right hand

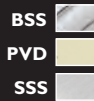

H2N1 502/13/R

**Grade 13 Lift Off
Thrust Bearing Hinge - Radius**

Dimensions

Length: 100mm
Width: 98mm
Thickness: 3.5mm
Maximum Loading: 120kg

Available in left or right hand

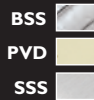

H2N1 503/11/R

**Grade 11 Lift Off
Thrust Bearing Hinge - Radius**

Dimensions

Length: 98mm
Width: 83mm
Thickness: 3mm
Maximum Loading: 80kg

Available in left or right hand

NOTES:
H2N SS Enduromax products are listed on the Secured by Design website as Police Preferred Specification.

CEN I 443/13

Grade 13 Ball Bearing Hinge
Grade 316 Stainless Steel

Dimensions

Length: 102mm
Width: 102mm
Thickness: 3mm
Maximum Loading: 120kg

Variations

CEN I 443/13/R - Radius



CEN I 433/13

Grade 13 Ball Bearing Hinge
Grade 316 Stainless Steel

Dimensions

Length: 102mm
Width: 76mm
Thickness: 3mm
Maximum Loading: 120kg

Variations

CEN I 433/13/R - Radius



INT I 433

Intumescent Hinge Liner

Dimensions

Length: 100mm
Width: 30mm

Variations

INT I 102

Width: 36mm

INT I 443

Width: 40mm



NOTES:

Intumescent hinge liners available (all packs are supplied pre-drilled in packs of 4). Call sales for details.
All Enduro hinges tested to and passed BS EN 1935:2002.



- BSS
- PVD
- SSS



HINI 4325/13R

Grade 13 Ball Bearing Hinge
Radius

Dimensions

Length: 102mm
Width: 76mm
Thickness: 2.5mm
Maximum Loading: 120kg

Variations

HINI 4325/13 - Square



- BSS
- PVD
- SSS



HINI 3225/11R

Grade 11 Ball Bearing Hinge
Radius

Dimensions

Length: 76mm
Width: 66mm
Thickness: 2.5mm
Maximum Loading: 80kg

Variations

HINI 3225/11 - Square



- BSS
- EB
- PVD
- SSS
- SZP



HINI 433/13

Grade 13 Ball Bearing Hinge

Dimensions

Length: 102mm
Width: 76mm
Thickness: 3mm
Maximum Loading: 120kg

Variations

HINI 433/13R - Radius

HINI 433P/13 - Enduro Plain Branded



NOTES:

Intumescent hinge liners available to suit 1/2 hour and 1 hour fire doors. For 1 hour requirement please use 2 packs.

HINI433SEC/13

Grade 13 Ball Bearing Security Hinge

Dimensions

Length: 102mm
Width: 76mm
Thickness: 3mm
Maximum Loading: 120kg

Variations

HINI433SEC/13/R - Radius



HINI433HT/13

Grade 13 Ball Bearing Hospital Tip Hinge
TS001 November 2005

Dimensions

Length: 102mm
Width: 76mm
Thickness: 3mm
Maximum Loading: 120kg



SCH14325/13

Grade 13 Slim Knuckle Hinge
10mm Dia. Narrow Knuckle

Dimensions

Length: 102mm
Width: 76mm
Thickness: 2.5mm
Maximum Loading: 120kg

Variations

SCH14325/13/R - Radius



SSS



SSS



BSS

SSS



NOTES:

Intumescent hinge liners available. Call sales for details.
All Enduro hinges tested to and passed BS EN 1935:2002.

BSS SSS **CSH1433****Grade I3 Contract
Ball Bearing Hinge****Dimensions**

Length:	102mm
Width:	76mm
Thickness:	3mm
Maximum Loading:	120kg

SSS **RBH1433RIG****Rising Butt Hinge****Dimensions**

Length:	102mm
Width:	75mm
Thickness:	3mm

Variations**RBH1433LEF - Left hand**BSS SSS PVD **B****HIN1322****Ball Bearing Hinge****Dimensions**

Length:	76mm
Width:	51mm
Thickness:	2mm



HIP1332

Plain Hinge

Dimensions

Length: 76mm
Width: 76mm
Thickness: 2mm



HIP14325

Plain Hinge

Dimensions

Length: 100mm
Width: 76mm
Thickness: 2.5mm



HIW13215

Washed Hinge

Dimensions

Length: 76mm
Width: 51mm
Thickness: 1.5mm



BSS SSS **HIWI 4325****Washed Hinge****Dimensions**

Length: 102mm
 Width: 76mm
 Thickness: 2.5mm

PB PC SC **HIN 424****Parliament Hinge****Dimensions**

Length: 102mm
 Width: 102mm
 Thickness: 4mm

B



XDB5760

Pushbar Panic Bolt
c/w Vertical Rods

Dimensions

Total Width: 760mm

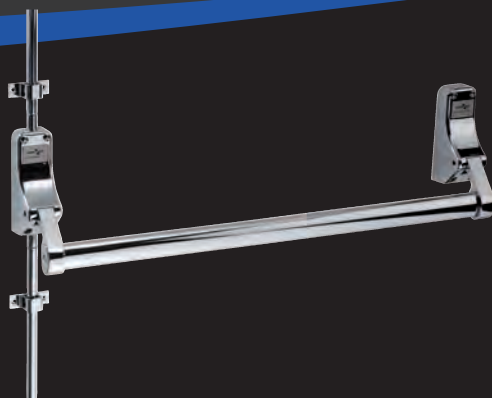

Variations



Code	Description	Size
XDL5760	Pushbar Panic Latch with Dogging Function c/w Strike	760mm
XDD5760	Rebated Double Pushbar Panic Bolt with Dogging Function c/w Vertical Rods	760mm
XIA5014	Metal Door Strike Pack to suit XDB5760 Panic Bolt	N/A
XIA5017	Follower to Rim Tail Converter	8mm

NOTES:

Type A Pushbar to BS EN 1125. For doors greater than 900mm a longer crossbar XCA5000 is available.



XSL5760V

**Narrow Style Pushbar
Panic Bolt**

c/w Pullman Latches, Rods and Covers

Dimensions

Total Width: 760mm

Code	Description	Size	Finish
XSL5760H	Narrow Style Pushbar Panic Bolt c/w Horizontal Pullman Latches Rods and Covers	760mm	SV
XSL5760	Narrow Style Pushbar Panic Latch c/w Strike	760mm	SV
XSD5760V	Narrow Style Rebated Double Door Pushbar Panic Bolt/Latch Set c/w Vertical Pullman Latches Rods and Covers	760mm	SV
XSA5002	Narrow Style Push Pad Latch	132 x36mm	PC PVD SC SV
XSA5002V	Narrow Style Push Pad c/w Vertical Pullman Latches, Rods and Cover (Mod Silver)	132 x36mm	SV
XSA5002H	Narrow Style Push Pad c/w Horizontal Pullman Latches Rods and Covers (Mod Silver)	132 x36mm	SV
XSA5003	Narrow Style (Handle) External Locking Attachment c/w Cylinder	150 x36mm	PC PVD SC SV
XSA5012	Dogging Device c/w Key to suit Narrow Style Panic Latch	132 x36mm	N/A

Variations



XIT5120



Touchbar Panic Latch
c/w strikes

Dimensions

Total Width: 1200mm

Variations

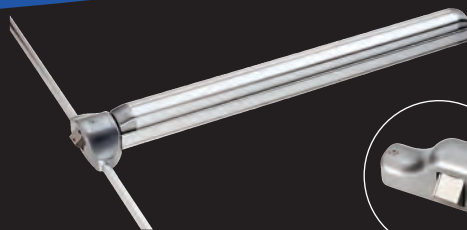

Code	Description	Size	Finish
XIT5120H	Touchbar Panic Bolt c/w Horizontal Pullman Latches, Rods and Covers	1200mm	SV
XIT5120V	Touchbar Panic Bolt c/w Vertical Pullman Latches, Rods and Covers	1200mm	SV
XIT5760	Touchbar Panic Latch c/w strikes	760mm	SV
XIT5760H	Touchbar Panic Bolt c/w Horizontal Pullman Latches, Rods and Covers	760mm	SV
XIT5760V	Touchbar Panic Bolt c/w Vertical Pullman Latches, Rods and Covers	760mm	SV
XID5120V	Rebated Double Door Touchbar Panic Bolt/Latch Set (XIT5120 + XIT5120)	1200mm	SV
XID5760V	Rebated Double Door Touchbar Panic Bolt/Latch Set (XIT5760 + XIT5760)	760mm	SV
XIA5000H	Horizontal Pullman Latches c/w Rods and Covers to suit Touchbar	N/A	SV
XIA5000V	Vertical Pullman Latches c/w Rods and Covers to suit Touchbar	N/A	SV
XIA5012	Dogging (Hold Back) Device c/w Key to suit Touchbar	N/A	SV

NOTES:

Type B Touchbar and Pullman Latches to BS EN 1125:1997.
Touchbar comes as standard with a unique photoluminescent pin stripe.



XIA5004

Photo Luminescent "Push Bar To Open" Sign to suit Touchbar

Dimensions

Length: 603mm
Width: 35mm



XIA5002

Pushpad Latch

Dimensions

Length: 125mm
Width: 90mm



XIA5003

**External Locking Attachment
c/w Cylinder**

Dimensions

Length: 125mm
Width: 90mm



NOTES:

Type B Pushpad Latch XIA5002 to BS EN 179. Can be master keyed, call masterkeying for details. XIA can be used with Eurospec rim cylinders see pages 293, 299 and 307.

DCS2026BC

VP Spring Range

275x62x45mm
Power Size 2-6

Suitable for Doors up to 120kg
and/or 1400mm Wide

Delayed Action Model

DCS2026BCDA Power Size 2-6

Alternative finishes to SV
available only when appropriate
cover pack is purchased

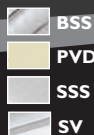

DCS2025BC

VP Spring Range

236x60x38.5mm
Power Size 2-5

Suitable for Doors up to 100kg
and/or 1250mm Wide

Variations

DCS2024BC Power Size 2-4

Delayed Action Model

DCS2025BCDA Power Size 2-5

Alternative finishes to SV
available only when appropriate
cover pack is purchased

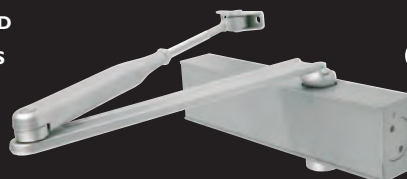
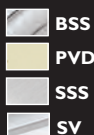

DCT2024

VP Template Range

207x55x40mm
Power Size 2-4

Suitable for Doors up to 80kg
and/or 1100mm Wide



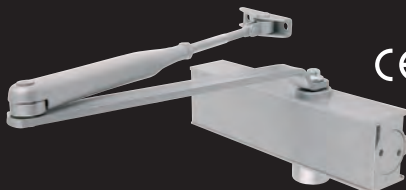
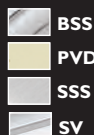

Alternative finishes to SV
available only when appropriate
cover pack is purchased



NOTES:

All models supplied with Easi - Fix template for trouble free installation.



- BSS 
- PVD 
- SSS 
- SV 

DCF2003

Fixed Range

178x42x64mm
Fixed Size 3

Suitable for Doors up to 60kg
and/or 950mm Wide

Alternative finishes to SV
available only when appropriate
cover pack is purchased

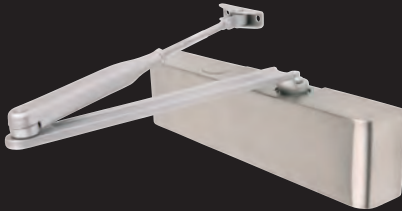

- BSS 
- PVD 
- SSS 

DCP2026

Cover Pack to suit DCS2026
c/w Cover, Arm and Bracket

Variations

- DCP2024/5** to suit DCS2024/25
- DCP2024T** to suit DCT2024
- DCP2003** to suit DCF2003

Alternative finishes to SV
available only when appropriate
cover pack is purchased



- SV 

DCX2107

Arms - Hold Open
to suit DCS2024/25/26

Alternative finishes to SV
available only when appropriate
cover pack is purchased

LDB5525

Easi - T 5 Lever BS Deadlock
64mm (2.5")

Variations

LDB5530 - 76mm (3")



LSB5525

Easi - T 5 Lever BS Sashlock
64mm (2.5")

Variations

LSB5530 - 76mm (3")



EDB5025

**Easi - T Euro Profile BS Cylinder
Deadlock - Complete Set**
64mm (2.5")

Variations

EDB5030 - 76mm (3")

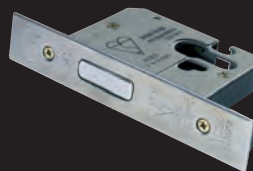

NOTES:

Radius forend and strike pack available as an accessory. Rebates available as an accessory. LDB and LSB to BS 3621:2007. Florentine bronze accessory packs available for LDB and LSB BS locks. Call sales for details.



PVD 
SSS 



ESB5026

Easi - T Euro Profile BS Cylinder Sashlock - Complete Set
64mm (2.5")

Variations

ESB5030 - 76mm (3")



PVD 
SSS 



EDB5025/CT

Easi - T Euro Profile BS Cylinder and Turn Deadlock - Complete Set
64mm (2.5")

Variations

EDB5030/CT - 76mm (3")



PVD 
SSS 



EDB5025/CT

Easi - T Euro Profile BS Cylinder and Turn Sashlock - Complete Set
64mm (2.5")

Variations

ESB5030/CT - 76mm (3")



NOTES:

Radius forend and strike pack available as an accessory. 1/2" and 1" SSS and PVD rebates available as an accessory. Call sales for details.

DLS0060EP

**Easi - T Din Euro Profile
Deadlock**

Dimensions

Backset: 60mm
Lockcase: 85x150mm

Variations

DLS0060EPSSS/R - Radius



DLS0060L

Easi - T Din Latch

Dimensions

Backset: 60mm
Lockcase: 85x150mm

Variations

DLS0060LSSS/R - Radius



DL57260EP

**Easi - T Din Euro Profile
Sashlock**

Dimensions

Backset: 60mm
Lockcase: 85x150mm
Centres: 72mm

Variations

DL57260EPSSS/R - Radius



NOTES:

1/2 Set fixing plate ALP5038 for B/T furniture available. 100mm Split Spindle with lock back feature ASS5100 available. BSS and PVD versions only available by adding strike plate and forend kit. Call sales for details.

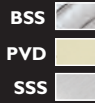

DLS7260NLA

**Easi - T Din Euro Profile
Nightlatch Anti Thrust Snib**

Dimensions

Backset: 60mm
Lockcase: 85x150mm
Centres: 72mm

Variations

DLS7260NLASSS/R - Radius

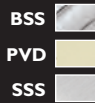

DLS7860WC

Easi - T Din Bathroom Lock

Dimensions

Backset: 60mm
Lockcase: 85x150mm
Centres: 78mm

Variations

DLS7860WCSSS/R - Radius

DLS7860WC/8/SSS - 8mm Follower

DLS7860WC/8/SSS/R - 8mm Follower Radius

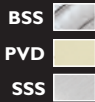

DLS7260ESC

**Easi - T Din Euro Profile
Escape Lock**

Dimensions

Backset: 60mm
Lockcase: 85x150mm
Centres: 72mm

Variations

DLS7260ESCSSS/R - Radius



NOTES:

CE category of use 3 - e.g. public buildings successfully tested to 200,000 cycles with a constant side force of 25N. Radius forend and strike pack available as an accessory. Rebates available as an accessory. Call sales for details.

LDS5325

Easi - T 3 Lever Deadlock
64mm (2.5")

Variations

LDS5330 - 3 Lever 76mm (3")

LDS5525 - 5 Lever 64mm (2.5")

LDS5530 - 5 Lever 76mm (3")



- PVD
- SSS



LSS5325

Easi - T 3 Lever Sashlock
64mm (2.5")

Variations

LSS5330 - 3 Lever 76mm (3")

LSS5525 - 5 Lever 64mm (2.5")

LSS5530 - 5 Lever 76mm (3")



- PVD
- SSS



RSL5030

Easi - T Roller Bolt Euro Profile Deadlock
76mm (3")



- SSS



NOTES:

Radius forend and strike pack available as an accessory. Rebates available as an accessory. Call sales for details.



PVD 

SSS 

B

EDS5025

Easi - T Euro Profile Deadlock
64mm (2.5")

Variations

EDS5030 - 76mm (3")



BSEN12209 FD3060



PVD 

SSS 

B

ESS5025

Easi - T Euro Profile Sashlock
64mm (2.5")

Variations

ESS5030 - 76mm (3")



BSEN12209 FD3060



PVD 

SSS 

ODS5025

**Easi - T Oval Profile Cylinder
Deadlock**
64mm (2.5")

Variations

ODS5030 - 76mm (3")



BSEN12209 FD3060



NOTES:

Florentine bronze accessory packs are available for Easi - T locks.
Call sales for details.

OSS5025

Easi - T Oval Profile Cylinder Sashlock
64mm (2.5")

Variations

OSS5030 - 76mm (3")



- PVD
- SSS



BAS5025

Easi - T Bathroom Lock
5mm Follower - 64mm (2.5")

Variations

BAS5030 - 5mm Follower 76mm (3")



- PVD
- SSS



MCN5025

Easi - T Euro Profile Cylinder Night Latch - Case Only
64mm (2.5")



- SSS



LCPI000

Security Cylinder Pull with Mini Lever

- PC
- PVD
- SAA
- SC





FLD8025
Flat Deadlock
64mm (2.5")

Variations

FLD8030 - 76mm (3")
FLD8040 - 102mm (4")



FLL8025
Original Flat Latch
64mm (2.5")

Variations

FLL8030 - 76mm (3")
FLL8040 - 102mm (4")

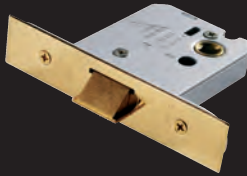

FLL5025
Easi-T Flat Latch
64mm (2.5")

Variations

FLL5030 - 76mm (3")
FLL5040 - 102mm (4")

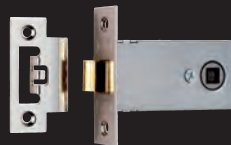

FLE8030
Mortice Box Latch
76mm (3")

NOTES:
Radius forend and strike pack available as an accessory. Rebates available as an accessory. Call sales for details.

TLD5030

Easi - T Tubular Dead Bolt
5mm Follower - 76mm (3")

Variations

TLD5040 - 5mm Follower 102mm (4")
TLD5050 - 5mm Follower 127mm (5")

TLD5830 - 8mm Follower 76mm (3")
TLD5840 - 8mm Follower 102mm (4")
TLD5850 - 8mm Follower 127mm (5")

 **EB**
 **SSS**

 **B**





TLS5030

**Easi - T Heavy Sprung
Tubular Latch**
76mm (3")

Variations

TLS5025 - 8mm Follower 64mm (2.5")
TLS5040 - 8mm Follower 102mm (4")
TLS5050 - 8mm Follower 127mm (5")



 **BSS**
 **EB**
 **SSS**

 **B**



TLS8030

**Easi - T Heavy Sprung
Tubular Latch**
8mm Follower - 76mm (3")

 **EB**
 **NP**
 **SC**

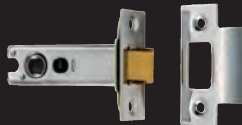

ULS5025

Easi - T Upright Latch
64mm (2.5")

Variations

ULS5030 - 76mm (3")

 **PVD**
 **SSS**



NOTES:

Conversion kit available for TLD5030 - TLD5850.
* TLS5025 is not bolt through.



URLS5325

Universal Replacement 3 Lever Sashlock
64mm (2.5")

Variations

URLS5330 - 3 Lever 76mm (3")

URLS5525 - 5 Lever 64mm (2.5")

URLS5530 - 5 Lever 76mm (3")



URES5025

Universal Replacement Euro Profile Sashlock
64mm (2.5")

Variations

URES5030 - 76mm (3")



UROS5025

Universal Replacement Oval Profile Sashlock
64mm (2.5")

Variations

UROS5030 - 76mm (3")



URBS5025

Universal Replacement Bathroom Sashlock
64mm (2.5")

Variations

URBS5030 - 76mm (3")

NOTES:

Universal replacement deadlocks also available URLD (Lever Dead), URED (Euro Dead) and UROD (Oval Dead). Call sales for details. Easily replaces 1st fix UK lock profiles.

DLE0055L

Easi - T Contract Din Latch
55mm

Dimensions

Backset: 55mm
Lockcase: 85x150mm

Variations

DLE0055L/R - 55mm Radius

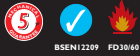

BSEN12209 FD30160



DLE0055EP

**Easi - T Contract Din Euro
Profile Deadlock**
55mm

Dimensions

Backset: 55mm
Lockcase: 85x150mm

Variations

DLE0055EP/R - 55mm Radius



BSEN12209 FD30160



DLE7255EP

**Easi - T Contract Din Euro
Profile Sashlock**
55mm

Dimensions

Backset: 60mm
Lockcase: 85x150mm
Centres: 72mm

Variations

DLE7255EP/R - 55mm Radius



BSEN12209 FD30160



NOTES:

CE successfully tested to 200,000 cycles with a constant side force of 25N. For use on doors up to 200kg. Rebates available as an accessory. Call sales for details.

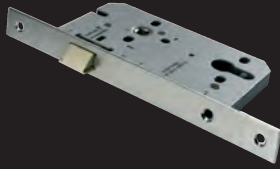

PVD 
SSS 

DLE7255NL

Easi - T Contract Din Euro Profile Nightlatch
55mm

Dimensions

Backset: 55mm
Lockcase: 85x150mm
Centres: 72mm

Variations

DLE7255NL/R - 55mm Radius



PVD 
SSS 

DLE7855WC

Easi - T Contract Din Bathroom Lock
55mm - 5mm Follower

Dimensions

Backset: 55mm
Lockcase: 85x150mm
Centres: 78mm

Variations

DLE7855WC/R - 55mm Radius
DLE7855WCSSS/8 - VWith 8mm Follower



NOTES:

CE category of use 3. For use in public areas where there is little incentive to take care and where there is a high chance of misuse. Rebates available as an accessory. Call sales for details.

ESE5025

Easi - T Economy Euro
Profile Sashlock
64mm (2.5")

Variations

ESE5030 - 76mm (3")



EDE5025

Easi - T Economy Euro
Profile Deadlock
64mm (2.5")

Variations

EDE5030 - 76mm (3")



OSE5025

Easi - T Economy Oval
Profile Sashlock
64mm (2.5")

Variations

OSE5030 - 76mm (3")

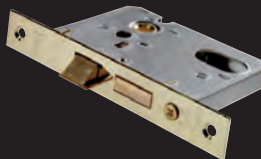



ODE5025

Easi - T Economy Oval Profile Deadlock
64mm (2.5")

Variations

ODE5030 - 76mm (3")

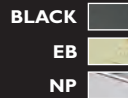

BAE5025

Easi - T Contract Bathroom Lock
64mm (2.5")

Variations

BAE5025/R - 64mm (2.5") Radius
BAE5030 - 76mm (3")
BAE5030/R - 76mm (3") Radius



ULE5025

Easi - T Contract Upright Latch
64mm (2.5")

Variations

ULE5025/R - 64mm (2.5") Radius
ULE5030 - 76mm (3")
ULE5030/R - 76mm (3") Radius



NOTES:
Rebate kits available. Call sales for details.

LDE5325

**Easi - T Contract 3 Lever
Deadlock**
64mm (2.5")

Variations

LDE5330 - 76mm (3")

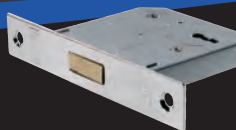

LSE5225

**Easi - T Contract 2 Lever
Sashlock**
64mm (2.5")

Variations

- LSE5225/R - 2 Lever 64mm (2.5") Radius
- LSE5230 - 2 Lever 76mm (3")
- LSE5230/R - 2 Lever 76mm (3") Radius
- LSE5325 - 3 Lever 64mm (2.5")
- LSE5325/R - 3 Lever 64mm (2.5") Radius
- LSE5330 - 3 Lever 76mm (3")
- LSE5330/R - 3 Lever 76mm (3") Radius

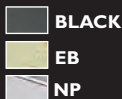

LSE5225/REB

**Easi - T Contract 2 Lever
Sashlock Rebated**
64mm (2.5")

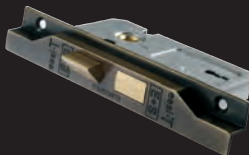
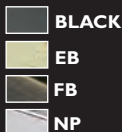

NOTES:

Rebate kits available for LSE sash locks. Call sales for details.



- JAP 
- PB 
- PC 
- SC 

B





RDE8043

Contract Rim Deadlock
102x76mm (4x3")

Variations

RLE8043 - Rim Latch
RSE8053 - 140x76mm (5.5x3") Rim Lock
RSE8064 - 152x102mm (6x4") Rim Lock



- BLACK 
- EB 
- PC 
- SC 
- WHITE 

B

DSB8225

Contract Door Security Bolt
57mm (2.25")

Variations

WSB8125 - 32mm (1.25") Window Bolt



DSK8000B

Door Security Bolt
Key - 35mm Length

Variations

DSK8000L - 65mm

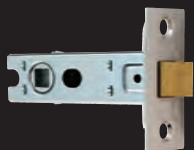

- EB 
- NP 

B

TLE5025

Bolt Through Contract Tubular Latch
64mm (2.5")

Variations

TLE5030 - 76mm (3")



NOTES:
TLE5025/30 c/w radius and square face plates.

RCB8260

**Contract Rim Cylinder
Rollerbolt**

60mm c/w Matching Finish
Cylinder and 3 Keys

Variations

RCB8260L - 60mm Lockcase Only



FD30/60



RCN8240

**Contract Rim Cylinder
Nightlatch**

40mm c/w Matching Finish
Cylinder and 3 Keys

Variations

RCN8240L - 40mm Lockcase Only



FD30/60



RCN8260

**Contract Rim Cylinder
Nightlatch**

60mm c/w Matching Finish
Cylinder and 3 Keys

Variations

RCN8260L - 60mm Lockcase Only



FD30/60

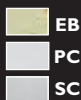

NOTES:

Outward opening striker plate AOS5000 for rim cylinder nightlatch available. RCB8260, RCN8240, RCN8260, RCN8340 and RCN8360 also available in white with EB cylinder.

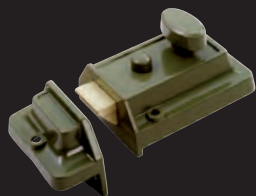
EB GN B **RCN8160****Traditional Rim Cylinder Nightlatch**

60mm c/w PB Rim Cylinder

EB PC SC **RCN8340****Deadlocking Rim Cylinder Nightlatch**

40mm c/w Matching Finish Cylinder and 3 Keys

Variations**RCN8340L** - 40mm Lockcase OnlyEB PC SC **RCN8360****Deadlocking Rim Cylinder Nightlatch**

60mm c/w Matching Finish Cylinder and 3 Keys

Variations**RCN8360L** - 60mm Lockcase Only

CYP71141

**Patented 15 Pin
Euro Single Cylinder**

Dimensions

Length: 41mm



Variations



Code	Description	Size	Finish
CYP71145	Euro Single Cylinder	45mm	PB/PC/SC

CYP71262

**Patented 15 Pin
Euro Double Cylinder**

Dimensions

Length: 62mm



Variations



Code	Description	Size	Finish
CYP71270	Euro Double Cylinder	70mm	PB/PC/SC
CYP71282	Euro Double Cylinder	82mm	PB/PC/SC

NOTES:

Also available keyed alike and under master key. Supplied with 2 keys. Patented until 2022. For cylinder queries and orders call the cylinder shop on 01254 274140.



CYP73526

**Patented 15 Pin
Standard Rim Cylinder**

Dimensions

Diameter: 32mm



FD30/60



CYP71362

**Patented 15 Pin
Euro Cylinder and Turn**

Dimensions

Length: 62mm

Code	Description	Size	Finish
CYP71370	Euro Cylinder and Turn	70mm	PB/PC/SC
CYP71382	Euro Cylinder and Turn	82mm	PB/PC/SC

Variations



BSEN1303



FD30/60



SECURITY CARD INFORMATION

DISTRIBUTOR

This security card is retained by the Distributor and a copy of this card must be produced to Eurospec with any orders for additional keys or cylinders.

The Distributor Card contains either the key number or Master Key System reference number.

OWNER

This security card is retained by the owner of the cylinder or Master Key System and must be produced to the Distributor with any orders for additional keys or cylinders.

The Owner Card contains either the key number or Master Key System reference number in addition to all Distributor details.

Patented until 2022



CYH71142

**Architectural Range
10 Pin Euro Single Cylinder**

Dimensions

Length: 42mm

Code	Description	Size	Finish
CYH71146	Euro Single Cylinder	46mm	PB/PC/SC
CYH71150	Euro Single Cylinder	50mm	PB/PC/SC

Variations



CYH71264

**Architectural Range
10 Pin Euro Double Cylinder**

Dimensions

Length: 64mm

Code	Description	Size	Finish
CYH71270	Euro Double Cylinder	70mm	PB/PC/SC
CYH71280	Euro Double Cylinder	80mm	PB/PC/SC
CYH71290	Euro Double Cylinder	90mm	PB/PC/SC
CYH712100	Euro Double Cylinder	100mm	PB/PC/SC

Variations



NOTES:

Also available keyed alike and under master key from stock.
Supplied with 3 keys. For cylinder queries and orders call the
cylinder shop on 01254 274140.

CYH7123240

**Architectural Range 10 Pin
Euro Double Offset Cylinder**

Dimensions

Offset: 32/40mm

Variations



Code	Description	Size	Finish
CYH7123240	Euro Double Offset Cylinder	32/40mm	PB/PC/SC
CYH7123250	Euro Double Offset Cylinder	32/50mm	PB/PC/SC
CYH7123540	Euro Double Offset Cylinder	35/40mm	PB/PC/SC
CYH7123545	Euro Double Offset Cylinder	35/45mm	PB/PC/SC
CYH7123550	Euro Double Offset Cylinder	35/50mm	PB/PC/SC
CYH7124045	Euro Double Offset Cylinder	40/45mm	PB/PC/SC
CYH7124050	Euro Double Offset Cylinder	40/50mm	PB/PC/SC
CYH7124550	Euro Double Offset Cylinder	45/50mm	PB/PC/SC
CYH7124555	Euro Double Offset Cylinder	45/55mm	PB/PC/SC
CYH7124060	Euro Double Offset Cylinder	40/60mm	PB/PC/SC

CYH71364

**Architectural Range 10 Pin
Euro Cylinder and Turn**

Dimensions

Length: 64mm

Variations



Code	Description	Size	Finish
CYH71370	Euro Cylinder and Turn	70mm	PB/PC/SC
CYH71380	Euro Cylinder and Turn	80mm	PB/PC/SC
CYH71390	Euro Cylinder and Turn	90mm	PB/PC/SC
CYH713100	Euro Cylinder and Turn	100mm	PB/PC/SC

NOTES:

Also available keyed alike and under master key from stock.
Supplied with 3 keys. For cylinder queries and orders call the cylinder shop on 01254 274140.



PB

PC

SC



CYH7133240

**Architectural Range 10 Pin
Euro Offset Cylinder and Turn**

Dimensions

Offset: 32/40mm

Variations



Code	Description	Size	Finish
CYH7133240	Euro Offset Cylinder and Turn	32/40mm	PB/PC/SC
CYH7133545	Euro Offset Cylinder and Turn	35/45mm	PB/PC/SC
CYH7134032	Euro Offset Cylinder and Turn	40/32mm	PB/PC/SC
CYH7134050	Euro Offset Cylinder and Turn	40/50mm	PB/PC/SC
CYH7134060	Euro Offset Cylinder and Turn	40/60mm	PB/PC/SC
CYH7134535	Euro Offset Cylinder and Turn	45/35mm	PB/PC/SC
CHY7134550	Euro Offset Cylinder and Turn	45/50mm	PB/PC/SC
CYH7135040	Euro Offset Cylinder and Turn	50/40mm	PB/PC/SC
CYH7135045	Euro Offset Cylinder and Turn	50/45mm	PB/PC/SC
CYH7136040	Euro Offset Cylinder and Turn	60/40mm	PB/PC/SC



PB

PC

SC



CYH72142

**Architectural Range 10 Pin
UK Oval Single Cylinder**

Dimensions

Length: 42mm

Variations



Code	Description	Size	Finish
CYH72146	UK Oval Single Cylinder	46mm	PB/PC/SC

CYH72264

**Architectural Range 10 Pin
 UK Oval Double Cylinder**

Dimensions

Length: 64mm



Variations



Code	Description	Size	Finish
CYH72270	Oval Double Cylinder	70mm	PB/PC/SC
CYH72280	Oval Double Cylinder	80mm	PB/PC/SC

CYH72364

**Architectural Range 10 Pin
 UK Oval Cylinder and Turn**

Dimensions

Length: 64mm



Variations



Code	Description	Size	Finish
CYH72370	Oval Cylinder and Turn	70mm	PB/PC/SC
CYH72380	Oval Cylinder and Turn	80mm	PB/PC/SC

NOTES:

Also available keyed alike and under master key from stock. Supplied with 3 keys. For cylinder queries and orders call the cylinder shop on 01254 274140.



CYH73525

Architectural Range 10 Pin Universal Rim Cylinder

Dimensions

Diameter: 45mm

Suitable for all major branded rim nightlatches and easily converts to suit 29mm diameter screw-in mortice locks.



FD30/60



CYH72-SP3 I

Architectural Range 10 Pin Scandinavian Oval Cylinder

Dimensions

Outer/Inner Set: 31mm

Code	Description	Size	Finish
CYH72-S03 I	Scandinavian Oval Cylinder	31mm Outer	PB/PC/SC
CYH72-SI3 I	Scandinavian Oval Cylinder	31mm Inner	PB/PC/SC

Variations



FD30/60

CYG71364CR

Classroom Euro Cylinder and Turn

Dimensions

Length: 64mm

-  **PB**
-  **PC**
-  **SC**



Variations



Code	Description	Size	Finish
CYG71370CR	Euro Cylinder and Turn	70mm	PB/PC/SC
CYG71380CR	Euro Cylinder and Turn	80mm	PB/PC/SC

CYH7PLO47

Open Shackle Padlock

Dimensions

Width: 47mm



-  **SC**



CYH7PLC55

Closed Shackle Padlock

Dimensions

Width: 55mm



-  **SC**



NOTES:

Also available keyed alike and under master key from stock. Supplied with 3 keys. For cylinder queries and orders call the cylinder shop on 01254 274140.



SECURITY CARD INFORMATION

DISTRIBUTOR

This security card is retained by the Distributor and a copy of this card must be produced to Eurospec with any orders for additional keys or cylinders.

The Distributor Card contains the Master Key System reference number.

OWNER

This security card is retained by the owner of the cylinder or Master Key System and must be produced to the Distributor with any orders for additional keys or cylinders.

The Owner Card contains either the key number or Master Key System reference number in addition to all Distributor details.

CYA71260

Architectural Range 5 Pin
Euro Double Cylinder

Dimensions

Length: 60mm



Variations



Code	Description	Size	Finish
CYA71270	Euro Double Cylinder	70mm	PB/PC/SC
CYA71280	Euro Double Cylinder	80mm	PB/PC/SC
CYA71290	Euro Double Cylinder	90mm	PB/PC/SC
CYA712100	Euro Double Cylinder	100mm	PB/PC/SC
CYA712110	Euro Double Cylinder	110mm	PB/PC/SC
CYA7123040	Offset Euro Double Cylinder	30/40mm	PB/PC/SC
CYA7123050	Offset Euro Double Cylinder	30/50mm	PB/PC/SC
CYA7123540	Offset Euro Double Cylinder	35/40mm	PB/PC/SC
CYA7123545	Offset Euro Double Cylinder	35/45mm	PB/PC/SC
CYA7123550	Offset Euro Double Cylinder	35/50mm	PB/PC/SC
CYA7124050	Offset Euro Double Cylinder	40/50mm	PB/PC/SC
CYA7124060	Offset Euro Double Cylinder	40/60mm	PB/PC/SC
CYA7124550	Offset Euro Double Cylinder	45/50mm	PB/PC/SC



CYA71140

**Architectural Range
5 Pin Euro Single Cylinder**

Dimensions

Length: 40mm

Code	Description	Size	Finish
CYA71145	Euro Single Cylinder	45mm	PB/PC/SC
CYA71150	Euro Single Cylinder	50mm	PB/PC/SC

Variations



FD3060



CYA71370/73520

**Architectural Range 5 Pin
Rim Cylinder and Euro
Cylinder/Turn Set**

Dimensions

Cylinder: 70mm
Rim Cylinder Dia: 45mm



FD3060



CYA71370/2

**Architectural Range 5 Pin
Rim Cylinder and Euro
Cylinder/Turn (Pair)**

Dimensions

Length: 70mm

NOTES:

CYA71140-50 Available keyed alike and under master key.
Supplied with 3 keys. CYA71370 supplied with 6 keys. For cylinder
queries and orders call the cylinder shop on 01254 274140.

CYA71360

**Architectural Range 5 Pin
Euro Cylinder and Turn**

Dimensions

Length: 60mm



Variations



Code	Description	Size	Finish
CYA71370	Euro Cylinder and Turn	70mm	PB/PC/SC
CYA71380	Euro Cylinder and Turn	80mm	PB/PC/SC
CYA71390	Euro Cylinder and Turn	90mm	PB/PC/SC
CYA713100	Euro Cylinder and Turn	100mm	PB/PC/SC
CYA7133040	Offset Euro Cylinder and Turn	30/40mm	PB/PC/SC
CYA7134030	Offset Euro Cylinder and Turn	40/30mm	PB/PC/SC
CYA7133545	Offset Euro Cylinder and Turn	35/45mm	PB/PC/SC
CYA7134535	Offset Euro Cylinder and Turn	45/35mm	PB/PC/SC
CYA7134060	Offset Euro Cylinder and Turn	40/60mm	PB/PC/SC
CYA7136040	Offset Euro Cylinder and Turn	60/40mm	PB/PC/SC

NOTES:

Also available keyed alike and under master key. Supplied with 3 keys. For cylinder queries and orders call the cylinder shop on 01254 274140.



- PB 
- PC 
- SC 

CYA72140

**Architectural Range 5 Pin
Oval Single Cylinder**

Dimensions

Length: 40mm

Code	Description	Size	Finish
CYA72145	Oval Single Cylinder	45mm	PB/PC/SC
CYA72150	Oval Single Cylinder	50mm	PB/PC/SC

Variations



FD30/60



- PB 
- PC 
- SC 

CYA72260

**Architectural Range 5 Pin
Oval Double Cylinder**

Dimensions

Length: 60mm

Code	Description	Size	Finish
CYA72270	Oval Double Cylinder	70mm	PB/PC/SC
CYA72280	Oval Double Cylinder	80mm	PB/PC/SC

Variations



FD30/60

CYA72360

**Architectural Range 5 Pin
Oval Cylinder and Turn**

Dimensions

Length: 62mm



B



Variations



Code	Description	Size	Finish
CYA72370	Oval Cylinder and Turn	70mm	PB/PC/SC
CYA72380	Oval Cylinder and Turn	82mm	PB/PC/SC

CYA73620

**Architectural Range 5 Pin
Threaded Rim Cylinder**

Dimensions

Diameter: 34mm

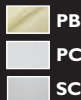

Variations



Code	Description	Size	Finish
CYA73620/2	Threaded Rim Cylinder - Pair	34mm dia.	PB/PC/SC

NOTES:

Also available keyed alike and under master key. Supplied with 3 keys. For cylinder queries and orders call the cylinder shop on 01254 274140.

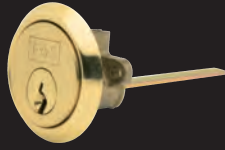

CYA73520

**Architectural Range 5 Pin
Standard Rim Cylinder**

Dimensions

Diameter: 45mm



FD30/60



Accessories

Code	Description	Size	Finish
CYA70445	Euro Single Thumbturn	45mm	PB/PC/SC
CYA70470	Euro Bathroom Cylinder	70mm	PB/PC/SC
CYZ70007	Large Thumbturn	35mm	PB/PC/SC
CYZ70008	Round Thumbturn		PB/PC/SC
CYZ70009	Large Thumbturn with Grip		PB/PC/SC
CYZ70011	Tall Semi-Circular Thumbturn		PB/PC/SC
CYZ70012	Peanut Shaped Thumbturn		PB/PC/SC
CYZ70016	Shaped Disabled Thumbturn		PB/PC/SC
CYZ73607	Cylinder Ring	7mm	PB/PC/SC
CYZ73610	Cylinder Ring	10mm	PB/PC/SC
CYZ70004	Screws for Profile Cylinders	65mm	EB/NP
CYZ70040	Screws for Rim Cylinders	N/A	N/A
CYZ70060	Tail for Rim Cylinders	55mm	N/A
CYZ70002	Key Rings	19mm	NP
CYZ70003	Key Tags	25mm	N/A

CYE71260

**Contract Range 5 Pin
Euro Double Cylinder**

Dimensions

Length: 60mm

 **NP**

 **SB**

B



Variations



Code	Description	Size	Finish
CYE71270	Euro Double Cylinder	70mm	NP/SB
CYE71280	Euro Double Cylinder	80mm	NP/SB
CYE71290	Euro Double Cylinder	90mm	NP/SB
CYE7123040	Offset Euro Double Cylinder	70mm	NP/SB
CYE7123050	Offset Euro Double Cylinder	80mm	NP/SB
CYE7123540	Offset Euro Double Cylinder	75mm	NP/SB
CYE7123545	Offset Euro Double Cylinder	80mm	NP/SB
CYE7123550	Offset Euro Double Cylinder	85mm	NP/SB
CYE7124050	Offset Euro Double Cylinder	90mm	NP/SB
CYE7124060	Offset Euro Double Cylinder	100mm	NP/SB
CYE7124550	Offset Euro Double Cylinder	95mm	NP/SB



NP 
SB 

CYE71145

**Contract Range 5 Pin
Euro Single Cylinder**

Dimensions

Length: 45mm

Code	Description	Size	Finish
CYE71140	Euro Single Cylinder	40mm	NP/SB

Variations



NP 
SB 
B

CYE71360

**Contract Range 5 Pin
Euro Cylinder and Turn**

Dimensions

Length: 60mm

Code	Description	Size	Finish
CYE71370	Euro Cylinder and Turn	70mm	NP/SB
CYE71380	Euro Cylinder and Turn	80mm	NP/SB
CYE71390	Euro Cylinder and Turn	90mm	NP/SB

Variations



CYE72140

**Contract Range 5 Pin
 Oval Single Cylinder**

Dimensions

Length: 40mm



Variations



Code	Description	Size	Finish
CYE72145	Oval Single Cylinder	45mm	NP/SB

CYE72260

**Contract Range 5 Pin
 Oval Double Cylinder**

Dimensions

Length: 60mm



Variations



Code	Description	Size	Finish
CYE72270	Oval Double Cylinder	70mm	NP/SB



NP 
SB 

CYE72360

**Contract Range 5 Pin
Oval Cylinder and Turn**

Dimensions

Length: 60mm

Code	Description	Size	Finish
CYE72370	Oval Cylinder and Turn	70mm	NP/SB

Variations

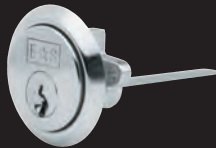

NP 
SB 

B

CYE73520

**Contract Range 5 Pin
Standard Rim Cylinder**

Dimensions

Diameter: 45mm



CYC71260

**Contract Range 5 Pin
Euro Double Cylinder**

Dimensions

Length: 60mm



Variations



Code	Description	Size	Finish
CYC71270	Euro Double Cylinder	70mm	EB/NP
CYC71280	Euro Double Cylinder	80mm	EB/NP

CYC71360

**Contract Range 5 Pin
Euro Cylinder and Turn**

Dimensions

Length: 60mm



Variations



Code	Description	Size	Finish
CYC71370	Euro Cylinder and Turn	70mm	EB/NP
CYC71380	Euro Cylinder and Turn	80mm	EB/NP



In addition to our stocked range of cylinders we are also one of the leading providers of masterkey cylinder locks in the UK.

Our previous systems include hospitals, sports stadiums, schools, universities, shopping centres, offices and even palaces. Masterkey systems are available in 5, 10 and 15 Pin:

15 Pin Offers

**MP
15**

Patented no unauthorised duplication key
65,000 key differs
Pins in 3 axis for security
Tested to BS EN 1303
C/W security card
Secured by Design accredited



10 Pin Offers

**MP
10**

10,000 key differs
Restricted key section
Extensive masterkey options
All keys stamped for ease of re-ordering
C/W security card
Secured by Design accredited



5 Pin Offers

**MP
5**

Entry level
10,000 key differs
Our widest range of sizes and finishes
Wide range of masterkey options at very competitive prices

We offer a comprehensive service from cutting spare keys to producing complex lock charts for customer sign off. Our experienced cylinder team will be happy to discuss your individual requirements. Please call us on 01254 274140 or fax us on 01254 274113.

SW10

**16mm Straight Lever on
Concealed Bearing Rose**

Dimensions

Rose: 6x50mm dia.
Lever: 16mm dia.

Variations

SW12: 19mm dia.
SW124: 19mm dia.
Sprung Rose



SW122

**16mm Safety Lever on
Concealed Sprung Rose**

Dimensions

Rose: 6x50mm dia.
Lever: 16mm dia.

Variations

SW123: 19mm dia. (DDA)
SW127: 22mm dia. (DDA)
SW11: 19mm dia. (DDA)
Concealed Bearing Rose
SW15: 22mm dia. (DDA)
Concealed Bearing Rose



SW13

**19mm Mitred Lever on
Concealed Bearing Rose**

Dimensions

Rose: 6x50mm dia.
Lever: 19mm dia.

Variations

SW125 - Sprung Rose



NOTES:

SW10, SW122, SW15 and SW127 only available in SSS. For matching escutcheons and thumbturns see pages 324-326.



BSS 

SSS 

SW14

**19mm Curved Lever on
Concealed Bearing Rose**

Dimensions

Rose: 6x50mm dia.
Lever: 19mm dia.

Variations

SW126 - Sprung Rose



BSEN1906

FD30/60

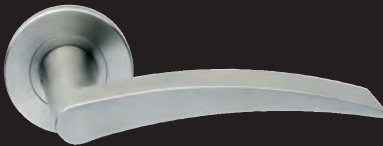

SSS 

SW16

**Designer Lever on Concealed
Bearing Rose - Solid**

Dimensions

Rose: 6x50mm dia.
Lever: 24mm



BSEN1906

FD30/60



SSS 

SW17

**Designer Lever on Concealed
Bearing Rose - Solid**

Dimensions

Rose: 6x50mm dia.
Lever: 19mm dia.



BSEN1906

FD30/60

SW18

SSS

**Carbon Fibre Lever on
Concealed Bearing Rose - Solid**

Dimensions

Rose: 6x50mm dia.
Lever: 19mm dia.



SW19

SSS

**Designer Lever on Concealed
Bearing Rose - Solid**

Dimensions

Rose: 6x50mm dia.
Lever: 16mm dia.



SW120

SSS

**Designer Lever on Concealed
Bearing Rose - Solid**

Dimensions

Rose: 6x50mm dia.
Lever: 22mm dia.



NOTES:
For matching escutcheons and thumbturns see pages 324-326.



SSS 

SW121

Designer Lever on Concealed Bearing Rose - Solid

Dimensions

Rose: 6x50mm dia.
Lever: 16mm dia.



SSS 

SW140

DDA Design Lever

Dimensions

Rose: 6x50mm dia.
Lever: 22mm



SSS 

SW141

DDA Design Lever

Dimensions

Rose: 6x50mm dia.
Lever: 22mm



SWLPI23

Lever on Latch Plate

Dimensions

Backplate: 180x45mm
Lever: 19mm dia.



BSEN 1906 FD3060



BSS



SSS



Code	Plate	Centres
SWOB	Latch	N/A
SWOE - DDA Compliant	Euro	47.5mm
SWOT - DDA Compliant	Bathroom	57mm
SWOP - DDA Compliant	Lock	57mm
SWOU - DDA Compliant	Oval	48.5mm
*SWOE/72 - DDA Compliant	Euro	72mm
*SWOT/78 - DDA Compliant	Bathroom	78mm

NOTES:

*SWOE/72 and SWOT/78 are suitable for use with DIN Locks.



SSS 

SWP17/300

Pull Handle - Solid

Dimensions

Centres: 300mm

Variations

SWP17/600

Centres: 600mm

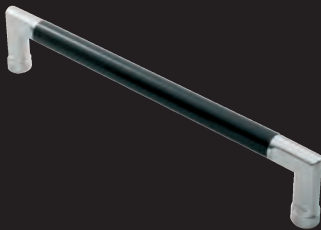

SSS 

SWP18/300

Pull Handle - Solid

Dimensions

Centres: 300mm

Variations

SWP18/600

Centres: 600mm

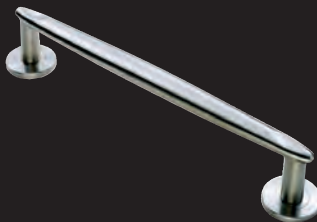

SSS 

SWP19/300

Pull Handle

Dimensions

Centres: 300mm

Variations

SWP19/600

Centres: 600mm



NOTES:

SWP19 shown with optional rose pack. Rose fixing pack
SWI34 available for pull SWP handles.

SWP120/300

Pull Handle

Dimensions

Centres: 300mm

Variations

SWP120/600

Centres: 600mm



FD30/60

PZD1150

D Pull Handle

Dimensions

Lever: 16mm dia.

Centres: 150mm

Variations



FD30/60

 **SSS**

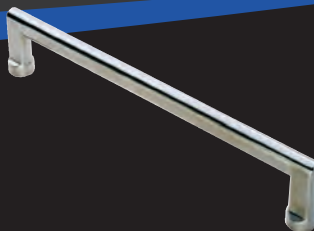

 **BSS**

 **SSS**



Code	Diameter	Centres
PZD1225	16mm	225mm
PZD1300	16mm	300mm
PAD1150	19mm	150mm
PAD1225	19mm	225mm
PAD1300	19mm	300mm
PAD1450 - DDA Compliant	19mm	450mm
*PAD1600 - DDA Compliant	19mm	600mm
*PFD1225	22mm	225mm
PFD1300	22mm	300mm
PBD1225	25mm	225mm
PBD1300	25mm	300mm
PCD1450 - DDA Compliant	30mm	450mm
PCD1600 - DDA Compliant	30mm	600mm
*PCD1800	30mm	1800mm



SSS 

PBG1250

Semi Circular Handle

Dimensions

Lever: 25mm dia.
Centres: 250mm



BSS 

SSS 

***PAC1225**

Cranked Pull Handle

Dimensions

Lever: 19mm
Centres: 225mm



Code	Diameter	Centres
PAC1300	19mm	300mm
*PAC1600 - DDA Compliant	19mm	600mm
*PFC1300	22mm	300mm
*PBC1300	25mm	300mm
*PCC1450 - DDA Compliant	30mm	450mm
*PCC1600 - DDA Compliant	30mm	600mm

NOTES:

* only available in SSS. Can be used back to back using BBF fixing pack. If fitting to hollow steel doors please contact your door supplier for fitting advice.

PAMI225

Mitred Pull Handle

Dimensions

Lever: 19mm dia.
Centres: 225mm

Variations



*PZTI150

T Pull Handle

Dimensions

Lever: 16mm dia.
Centres: 150mm

Variations



SSS

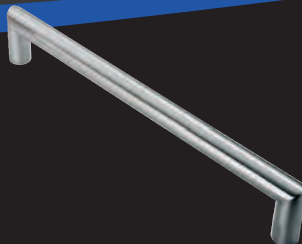

Code	Diameter	Centres
PAMI300	19mm	300mm
PCMI450	30mm	450mm
PCMI600	30mm	600mm

BSS

SSS



Code	Diameter	Centres
PATI225	19mm	225mm
*PATI300	19mm	300mm
*PFTI225	22mm	225mm
PFTI300	22mm	300mm
*PBTI225	25mm	225mm
*PBTI300	25mm	300mm
PCTI450 - DDA Compliant	30mm	450mm
*PCTI600 - DDA Compliant	30mm	600mm
*PCTI1000	30mm	1000mm
PCTI1800	30mm	1630mm



BSS 
PVD 
SSS 



ML05 I500/01/03

Evolution Handle

Dimensions

Backplate: 220x32mm
Centres: 92mm



SSS 

SWNP11

Narrow Plate Safety Lever

Dimensions

Backplate: 220x32mm
Centres: 92mm



SSS 

SWNP120

Narrow Plate Straight Lever

Dimensions

Backplate: 220x32mm
Centres: 92mm



NOTES:

* only available in SSS.

Narrow plate levers are suitable for multi-point locking systems.
SW134 Rose fixing pack for 16-25mm dia. pull handles available.

SWNP40

DDA Design
Narrow Plate Lever

Dimensions

Backplate: 220x32mm
Centres: 92mm



SWNP41

DDA Design
Narrow Plate Lever

Dimensions

Backplate: 220x32mm
Centres: 92mm



SW101

Blank Escutcheon

Dimensions

Rose: 50mm dia.
Rose Thickness: 6mm



NOTES:
Narrow plate levers are suitable for multi-point locking systems.



BSS 

SSS 

SW102

Euro Escutcheon

Dimensions

Rose: 50mm dia.
Rose Thickness: 6mm



FD30/60



BSS 

SSS 

SW103

Lever Lock Escutcheon

Dimensions

Rose: 50mm dia.
Rose Thickness: 6mm



FD30/60



BSS 

SSS 

SW104

Oval Escutcheon

Dimensions

Rose: 50mm dia.
Rose Thickness: 6mm



FD30/60

SW105

Disabled Thumbturn and Release

Dimensions

Rose: 50mm dia.

Variations

SW105i

With indicator



FD3060



SW106

Designer Thumbturn and Release

Dimensions

Rose: 50mm dia.

Variations

SW106i

With indicator



FD3060



SW107i

Standard Thumbturn and Release c/w indicator

Dimensions

Rose: 50mm dia.

Variations

SW107

Without indicator



FD3060





BSS 

SSS 

SWKNR

Mortice Knob
Unsprung

Dimensions

Rose: 50mm dia.
Knob: 58mm dia.



BSEN1196 FD30140



BSS 

SSS 

CABI100

Silent Pattern Cabin Hook

Dimensions

100mm

Variations

CABI150: 150mm

CABI200: 200mm

SW3041

 **BSS/SSS**

Lever on Concealed Sprung Rose

Dimensions

Rose: 50mm dia.
Lever: 18mm dia.



SW3042

 **BSS/SSS**

Lever on Concealed Sprung Rose

Dimensions

Rose: 50mm dia.
Lever: 22mm dia.



SW3043

 **BSS/SSS**

Lever on Concealed Sprung Rose

Dimensions

Rose: 50mm dia.
Lever: 24mm dia.



NOTES:
For matching escutcheons and thumbturns see pages 329-330.



BSS/SSS 

SW3044

Lever on Concealed Sprung Rose

Dimensions

Rose: 50mm dia.
Lever: 20mm dia.



BSEN1906 FD3060



BSS/SSS 

SW3045

Lever on Concealed Sprung Rose

Rose: 50mm dia.
Lever: 22mm dia.



BSEN1906 FD3060



BSS/SSS 

SW3046

Lever Lock Escutcheon

Dimensions

Rose: 50mm dia.
Rose Thickness: 6mm



FD3060

SW3047

 **BSS/SSS**

Oval Escutcheon

Dimensions

Rose: 50mm dia.
Rose Thickness: 6mm



SW3048

 **BSS/SSS**

Euro Escutcheon

Dimensions

Rose: 50mm dia.
Rose Thickness: 6mm



SW3049

 **BSS/SSS**

Designer Thumbturn and Release

Dimensions

Rose: 50mm dia.
Rose Thickness: 6mm





BSS 

SSS 

FPH I 000

Flush Pull
Rectangular

Dimensions

Length: 100mm
Height: 50mm

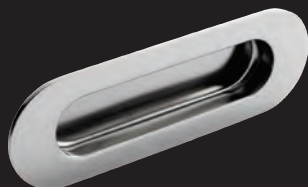

BSS 

SSS 

FPH I 001

Flush Pull
Radius

Dimensions

Length: 120mm
Height: 40mm



BSS 

SSS 

FPH I 002

Flush Pull
Circular

Dimensions

Diameter: 48mm



FPHI003

Flush Pull
Circular

Dimensions

Diameter: 78mm



BSS



SSS



FPHI004

Flush Pull
Circular

Dimensions

Diameter: 89mm



BSS



SSS



CPDI096

Cabinet D Handle

Dimensions

Lever: 10mm dia.
Centres: 96mm

Variations

CPDI128: 128mm Centres

CPDI160: 160mm Centres



BSS



SSS





BSS 

SSS 

CPH1096

Cabinet Curved Pull Handle

Dimensions

Lever: 10mm dia.
Centres: 96mm

Variations

CPH1128: 128mm Centres
CPH1160: 160mm Centres

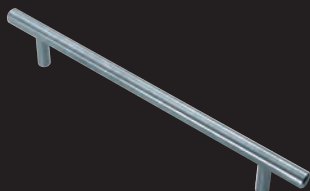

BSS 

SSS 

CPT1096

Straight Pull Handle

Dimensions

Lever: 10mm dia.
Centres: 96mm

Variations

CPT1128: 128mm Centres
CPT1160: 160mm Centres



BSS 

SSS 

CKN1016

Cabinet Knob

Dimensions

Diameter: 16mm

Variations

CKN1020: 20mm dia.
CKN1025: 25mm dia.



CKRI025

Round Ball Cabinet Knob

Dimensions

Diameter: 25mm

Variations

CKRI030: 30mm dia.



DSFI030

**Floor Mounted Door Stop
Pedestal**

Dimensions

Diameter: 30mm



DSFI031

**Floor Mounted Door Stop
Large**

Dimensions

Diameter: 78mm





BSS 

SSS 

DSF I032

Floor Mounted Door Stop

Dimensions

Diameter: 44mm



BSS 

SSS 

DSW I015

Wall Mounted Door Stop

Dimensions

Diameter: 16mm



BSS 

SSS 

HCH I010

Hat and Coat Hook

Dimensions

Diameter: 10mm

Height: 150mm



HCHI011

Coat Hook



Dimensions

Diameter: 10mm
Height: 80mm



HCHI012

Flat Coat Hook



Dimensions

70x20mm



HCHI013

Flat Hat and Coat Hook



Dimensions

175x20mm





BSS 

SSS 

HCH1014

Hat and Double Coat Hook

Dimensions

Rose: 47mm dia.
Height: 180mm



BSS 

SSS 

HCH1015

Double Coat Hook

Dimensions

Rose: 47mm dia.
Height: 100mm



BSS 

SSS 

HCH1016

Coat Hook

Dimensions

Rose: 32mm dia.



HCHI017

Coat Hook
Concealed Fix

Dimensions

Diameter: 16mm

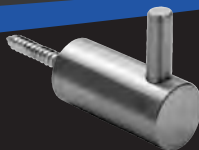

HCHI018

Buffered Coat Hook

Dimensions

Rose: 50mm dia.
Length: 90mm



LET1050A

Letter a

Dimensions

50mm

Variations



Code	Description	Size
LET1050B	Letter b	50mm
LET1050C	Letter c	50mm
LET10100A	Letter a	100mm
LET10100B	Letter b	100mm
LET10100C	Letter c	100mm

123

BSS 

SSS 

NUM10500

Numeral 0

Dimensions

50mm

Variations



FD1060

Code	Description	Size
NUM10501	Numeral 1	50mm
NUM10502	Numeral 2	50mm
NUM10503	Numeral 3	50mm
NUM10504	Numeral 4	50mm
NUM10505	Numeral 5	50mm
NUM10506/9	Numeral 6/9	50mm
NUM10507	Numeral 7	50mm
NUM10508	Numeral 8	50mm
NUM10100	Numeral 0	100mm
NUM10101	Numeral 1	100mm
NUM10102	Numeral 2	100mm
NUM10103	Numeral 3	100mm
NUM10104	Numeral 4	100mm
NUM10105	Numeral 5	100mm
NUM10106/9	Numeral 6/9	100mm
NUM10107	Numeral 7	100mm
NUM10108	Numeral 8	100mm

SEX1011

Male Symbol

Dimensions

76mm dia.

Variations



BSS



SSS



Code	Description	Size	Finish	
SEX1012	Female Symbol	76mm dia.	BSS/SSS	
SEX1014	Shower Symbol	76mm dia.	BSS/SSS	
SEX1015	Fire Door Symbol	76mm dia.	BSS/SSS	
SEX1016	Fire Door Symbol	76mm dia.	BSS/SSS	
SEX1017	Disabled Symbol	76mm dia.	BSS/SSS	
SEX1018	Unisex Symbol	76mm dia.	BSS/SSS	
SEX1019	Baby Change Symbol	76mm dia.	BSS/SSS	
FPA1301	Pull Symbol	75 x30mm	BSS/SSS	
FPA1302	Push Symbol	75 x30mm	BSS/SSS	
SEX1021	Fire Escape Sign	76mm dia.	BSS/SSS	
SEX1020	No Smoking Sign	210 x148mm	BSS/SSS	



BSS 

SSS 

FPP1300

Plain Finger Plate





Dimensions

300x75mm

Variations



FD3000

Code	Description	Size	Finish	
FPP1350	Plain Finger Plate	350x75mm	BSS/SSS	
FPP1500	Plain Finger Plate	500x75mm	BSS/SSS	
FPP1650	Plain Finger Plate	650x75mm	BSS/SSS	
FPP1301	Pull Finger Plate	300x75mm	BSS/SSS	
FPP1351	Pull Finger Plate	350x75mm	BSS/SSS	
FPP1302	Push Finger Plate	300x75mm	BSS/SSS	
FPP1352	Push Finger Plate	350x75mm	BSS/SSS	

KPPI 590

Kickplate

Dimensions

590x150mm

Individually Packed
c/w Matching pozi screws and
corner protectors

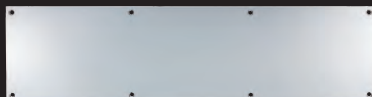

Variations



Code	Description	Size	Finish
KPPI 615	Kickplate	615x150mm	BSS/PVD/SSS
KPPI 650	Kickplate	650x150mm	BSS/PVD/SSS
KPPI 675	Kickplate	675x150mm	BSS/PVD/SSS
KPPI 690	Kickplate	690x150mm	BSS/PVD/SSS
KPPI 715	Kickplate	715x150mm	BSS/PVD/SSS
KPPI 725	Kickplate	725x150mm	BSS/PVD/SSS
KPPI 750	Kickplate	750x150mm	BSS/PVD/SSS
KPPI 790	Kickplate	790x150mm	BSS/PVD/SSS
KPPI 815	Kickplate	815x150mm	BSS/PVD/SSS
KPPI 805	Kickplate	805x150mm	BSS/PVD/SSS
KPPI 830	Kickplate	830x150mm	BSS/PVD/SSS
KPPI 855	Kickplate	855x150mm	BSS/PVD/SSS
KPPI 880	Kickplate	880x150mm	BSS/PVD/SSS
KPPI 905	Kickplate	905x150mm	BSS/PVD/SSS
KPPI 890	Kickplate	890x150mm	BSS/PVD/SSS
KPPI 915	Kickplate	915x150mm	BSS/PVD/SSS



BSS 

SSS 

BBT1080

Straight Barrel Bolt

Dimensions

80x38mm

Variations

BBT1100: 100x38mm

BBT1150: 150x38mm

BBT1200: 200x38mm



BSS 

SSS 

BBT1080CR

Cranked Barrel Bolt

Dimensions

80x38mm

Variations

BBT1100CR: 100x38mm

BBT1150CR: 150x38mm

BBT1200CR: 200x38mm



HBS1038

Saddle
to suit 38mm dia. handrail

Variations

HBS1050
to suit 50mm dia. handrail



FD3060



BSS



SSS



HRB1000BSS/P62

Handrail Bracket

Dimensions

Projection: 62mm

Variations

HRB1000BSS/P85 (DDA Compliant)

Projection: 85mm



FD3060



BSS



SSS



OCP1000

Oval Cylinder Pull

Dimensions

78x44mm



FD3060



BSS



PVD



SSS





BSS 
PVD 
SSS 

ECP 1000

Euro Cylinder Pull

Dimensions

78x44mm



FD3060



BSS 
PVD 
SSS 

PCP 1000

Lever Lock Cylinder Pull



Dimensions

78x44mm



FD3060



BSS 
PVD 
SSS 

BCP 1000

Blank Cylinder Pull

Dimensions

78x44mm



FD3060

RCP1000

Rim Cylinder Pull

Dimensions

78x44mm



FD30/60

-  **BSS**
-  **PVD**
-  **SSS**



FBT1008

Lever Action Flush Bolt

Dimensions

203x20mm

Variations

FBT1008/R - Radius



FD30/60

-  **BSS**
-  **SSS**



AA813

(Formerly SOC4068)

Flush Bolt Socket



13mm Slot Size

Dimensions

64x20mm



FD30/60

-  **CP**
-  **PB**
-  **SN**



BSS SSS **B****CSL I 190****19mm Safety Lever****Dimensions**

Rose: 52mm dia.
Lever: 19mm dia.

Variations**CSL I 220**

Lever: 22mm dia.

SSS **B****CSL I 191****19mm Straight Lever****Dimensions**

Rose: 52mm dia.
Lever: 19mm dia.

BSS SSS **B****CSL I 192****19mm Mitred Lever
Round Bar****Dimensions**

Rose: 52mm dia.
Lever: 19mm dia.

**NOTES:**

For matching escutcheons and thumbturns see page 350-351.

CSLI 193

19mm Curved Lever

Dimensions

Rose: 52mm dia.
Lever: 19mm dia.

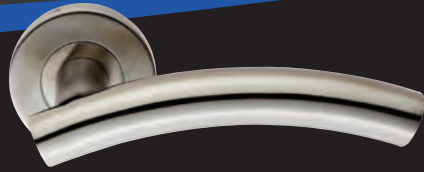

CSLI 194

19mm Straight Lever

Dimensions

Rose: 52mm dia.
Lever: 19mm dia.



CSLI 195

19mm Mitred Lever
Oval Bar

Dimensions

Rose: 52mm dia.
Lever: 19mm dia.



Lever Section 

NOTES:

For matching escutcheons and thumbturns see page 350-351.

SSS **CSLI 121****Lever on Sprung Rose****Dimensions**

Rose: 52mm dia.



BSEN1906 FD3060

SSS **CSLI 127****Lever on Sprung Rose****Dimensions**

Rose: 52mm dia.



BSEN1906 FD3060

SSS **CSLI 134****Lever on Sprung Rose****Dimensions**

Rose: 52mm dia.



BSEN1906 FD3060

CSLI 160

Lever on Sprung Rose

Dimensions

Rose: 52mm dia.



CST1025

Disabled Thumbturn and Release
c/w Additional Non Indicator Rose

Dimensions

Rose: 52mm dia.
Rose Thickness: 8mm



CST1015

Thumbturn and Release
c/w Additional Non Indicator Rose

Dimensions

Rose: 52mm dia.
Rose Thickness: 8mm





BSS 

SSS 



CSU I 005

Oval Escutcheon

Dimensions

Rose: 52mm dia.
Rose Thickness: 8mm



FD3060



BSS 

SSS 



CSP I 005

Lock Escutcheon

Dimensions

Rose: 52mm dia.
Rose Thickness: 8mm



FD3060



BSS 

SSS 



CSE I 005

Euro Escutcheon

Dimensions

Rose: 52mm dia.
Rose Thickness: 8mm



FD3060

CSLPI 190

Safety Lever on Backplate

Dimensions

Backplate: 170x45x8mm
Lever: 19mm dia.



FD3046

Variations - Radius



BSS



SSS



Code	Description	Size	Finish
CPRB1170	Radius Latch Plates	170x45x8mm	BSS/SSS
CPRE1170/72	Radius Euro Cylinder Plates (Din 72c/c)	170x45x8mm	BSS/SSS
CPRE1170	Radius Euro Cylinder Plates (47.5c/c)	170x45x8mm	BSS/SSS
CPRP1170	Radius Lever Key Plates	170x45x8mm	BSS/SSS
CPRT1170/78	Radius Bathroom Plates (Din 78c/c) + Small Indicator + Turn	170x45x8mm	BSS/SSS
CPRT1170	Radius Bathroom Plates (UK 57c/c) + Small Indicator + Turn	170x45x8mm	BSS/SSS
CPRTL1170/78	Radius Bathroom Plates (Din 78c/c) + Large Indicator + Turn	170x45x8mm	BSS/SSS
CPRTL1170	Radius Bathroom Plates (UK 57c/c) + Large Indicator + Turn	170x45x8mm	BSS/SSS
CPRU1170	Radius UK Oval Cylinder Plates (48.5c/c)	170x45x8mm	BSS/SSS

Square

CPSB1170	Square Latch Plates	170x45x8mm	BSS/SSS
CPSE1170/72	Square Euro Cylinder Plates (Din 72c/c)	170x45x8mm	BSS/SSS
CPSE1170	Square Euro Cylinder Plates (47.5c/c)	170x45x8mm	BSS/SSS
CPSP1170	Square Lever Key Plates	170x45x8mm	BSS/SSS
CPST1170/78	Square Bathroom Plates (Din 78c/c) + Small Indicator + Turn	170x45x8mm	BSS/SSS
CPST1170	Square Bathroom Plates (UK 57c/c) + Small Indicator + Turn	170x45x8mm	BSS/SSS
CPSTL1170/78	Square Bathroom Plates (Din 78c/c) + Large Indicator + Turn	170x45x8mm	BSS/SSS
CPSTL1170	Square Bathroom Plates (UK 57c/c) + Large Indicator + Turn	170x45x8mm	BSS/SSS
CPSU1170	Square UK Oval Cylinder Plates (48.5c/c)	170x45x8mm	BSS/SSS

BSS SSS **CSLPI 191****Straight Lever on Backplate****Dimensions**

Backplate: 170x45x8mm
Lever: 19mm dia.

**Variations - Radius**

Code	Description	Size	Finish
CPRB1170	Radius Latch Plates	170x45x8mm	BSS/SSS
CPRE1170/72	Radius Euro Cylinder Plates (Din 72c/c)	170x45x8mm	BSS/SSS
CPRE1170	Radius Euro Cylinder Plates (47.5c/c)	170x45x8mm	BSS/SSS
CPRP1170	Radius Lever Key Plates	170x45x8mm	BSS/SSS
CPRT1170/78	Radius Bathroom Plates (Din 78c/c) + Small Indicator + Turn	170x45x8mm	BSS/SSS
CPRT1170	Radius Bathroom Plates (UK 57c/c) + Small Indicator + Turn	170x45x8mm	BSS/SSS
CPRTL1170/78	Radius Bathroom Plates (Din 78c/c) + Large Indicator + Turn	170x45x8mm	BSS/SSS
CPRTL1170	Radius Bathroom Plates (UK 57c/c) + Large Indicator + Turn	170x45x8mm	BSS/SSS
CPRU1170	Radius UK Oval Cylinder Plates (48.5c/c)	170x45x8mm	BSS/SSS

CPSB1170	Square Latch Plates	170x45x8mm	BSS/SSS
CPSE1170/72	Square Euro Cylinder Plates (Din 72c/c)	170x45x8mm	BSS/SSS
CPSE1170	Square Euro Cylinder Plates (47.5c/c)	170x45x8mm	BSS/SSS
CPSP1170	Square Lever Key Plates	170x45x8mm	BSS/SSS
CPST1170/78	Square Bathroom Plates (Din 78c/c) + Small Indicator + Turn	170x45x8mm	BSS/SSS
CPST1170	Square Bathroom Plates (UK 57c/c) + Small Indicator + Turn	170x45x8mm	BSS/SSS
CPSTL1170/78	Square Bathroom Plates (Din 78c/c) + Large Indicator + Turn	170x45x8mm	BSS/SSS
CPSTL1170	Square Bathroom Plates (UK 57c/c) + Large Indicator + Turn	170x45x8mm	BSS/SSS
CPSU1170	Square UK Oval Cylinder Plates (48.5c/c)	170x45x8mm	BSS/SSS

Square

CSD1150

19mm D Pull Handle

Dimensions

Centres: 150mm
Lever: 19mm dia.



Code	Diameter	Centres
CSD1225	19mm	225mm
CSD1300	19mm	300mm
CSD1425	19mm	425mm
CSD1450 - DDA Compliant	19mm	450mm
CSD1600 - DDA Compliant	19mm	600mm
CFPT1450	22mm	450mm
CFPT1600	22mm	600mm
CSR1005 - Covered Rose Pack	54mm	N/A

CSK1058

**Mortice Knob
on Sprung Rose**

Dimensions

Rose: 54mm dia.





SSS

B

SSL I 401**Square Mitred Lever**
on Sprung Square Rose**Dimensions**

Rose: 52x52mm
 Lever: 19mm
 Rose Thickness: 8mm



BSEN1906 FD3060



SSS

B

SSL I 402**Flat Lever**
on Sprung Square Rose**Dimensions**

Rose: 52x52mm
 Lever: 10x19mm
 Rose Thickness: 8mm



BSEN1906 FD3060



SSS

B

SSL I 403**Rectangular Lever**
on Sprung Square Rose**Dimensions**

Rose: 52x52mm
 Lever: 24x12mm
 Rose Thickness: 8mm



BSEN1906 FD3060

NOTES:

For matching escutcheons and thumbturns see pages 357-358.

SSL I 404

Shaped Lever
on Sprung Square Rose

Dimensions

Rose: 52x52mm
Rose Thickness: 8mm



SSS

B

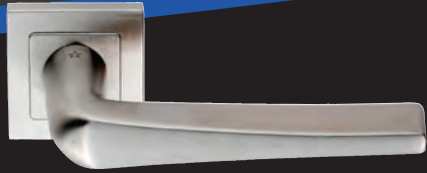

SSL I 405

Square Lever
on Sprung Square Rose

Dimensions

Rose: 52x52mm
Lever: 16mm
Rose Thickness: 8mm



BSS/SSS

B



SSL I 406

Square Mitred Lever
on Sprung Square Rose

Dimensions

Rose: 52x52mm
Lever: 22mm
Rose Thickness: 8mm



BSS/SSS

B

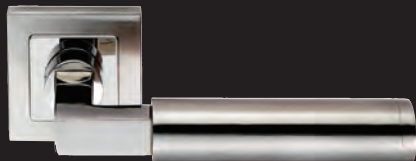

NOTES:

For matching escutcheons and thumbturns see pages 357-358.

BSS/SSS SSS **SSEI 405/DUO****Euro Square Escutcheon****Dimensions**

Rose: 52x52mm
 Rose Thickness: 8mm



FD3060

BSS/SSS SSS **SSP 1405/DUO****Lever Lock Square Escutcheon****Dimensions**

Rose: 52x52mm
 Rose Thickness: 8mm



FD3060

BSS/SSS SSS **SSU 1405/DUO****Oval Square Escutcheon****Dimensions**

Rose: 52x52mm
 Rose Thickness: 8mm



FD3060

NOTES:

Square escutcheons are supplied with both a polished and satin inner to allow for a single or dual finish.

SST I415/DUO

Square Thumbturn and Release
on Square Rose

Dimensions

Rose: 52x52mm

Variations
SST I415I/DUO

With indicator



SSRI 405SSS/DUO

Square Rose Pack
for Pull Handles

Dimensions

Rose: 52x8mm



SSDI 415

16mm Square T Pull Handle

Dimensions

Centres: 150mm

Variations

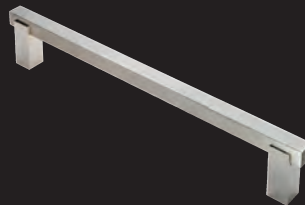

Code	Centres
SSDI 415	150mm
SSDI 422	225mm
SSDI 430	300mm
SSDI 445 - DDA Compliant	450mm
SSDI 460 - DDA Compliant	600mm

SSS **SSF1415****Flat T Pull Handle****Dimensions**

Centres: 150mm

Variations

Code	Centres
SSF1415	150mm
SSF1422	225mm
SSF1430	300mm
SSF1445 - DDA Compliant	450mm
SSF1460 - DDA Compliant	600mm

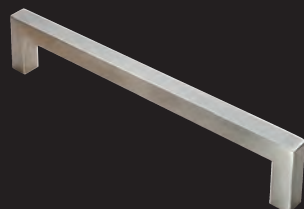
SSS **SSM1415****Square Mitred Pull Handle****Dimensions**

Centres: 150mm

Variations

Code	Centres
SSM1415	150mm
SSM1422	225mm
SSM1430	300mm
SSM1445 - DDA Compliant	450mm
SSM1460 - DDA Compliant	600mm

NOTES:

SSR1405 is supplied with both a polished and satin inner to allow for a single or dual finish. Optional rose pack available.

PH003

Designer Pull Handle

Dimensions

Rose: 51mm dia.
Rose Thickness: 10mm



PH115

Designer Pull Handle

Dimensions

Rose: 51mm dia.
Rose Thickness: 10mm

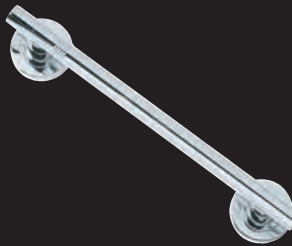
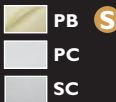

PH116

Designer Pull Handle

Dimensions

Rose: 51mm dia.
Rose Thickness: 10mm

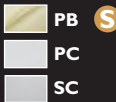

NOTES:

For matching escutcheons and thumbturns see pages 153-156.

Special order contact sales for details.



- S** PB 
- PB/SB 
- S** PC 
- PC/SC 
- S** SC 



PH118

Designer Pull Handle

Dimensions

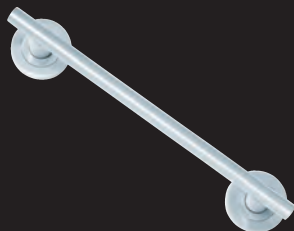
Rose: 51 mm dia.



- S** PB 
- PC 
- SC 

PH121

Designer Pull Handle

Dimensions

Rose: 51 mm dia.



- S** PB 
- PB/SB 
- S** PC 
- PC/SC 
- S** SC 

PH127

Designer Pull Handle

Dimensions

Rose: 51 mm dia.



PH225

D Pull Handle

Dimensions

Centres: 225mm



PB



PC



SC



PH300

D Pull Handle

Dimensions

Centres: 300mm



PB



PC



SC



NOTES:

For matching escutcheons and thumbturns see pages 153-156.

PAA **LRS6000**

Safety Lever
DDA BS8300 Compliant

Dimensions

Rose: 50mm dia.
Rose Thickness: 8mm
Lever: 22mm dia.
Lever Length: 144mm

Variations**LRS6001**

Lever: 19mm dia.
Lever Length: 137mm



BSEN1906 FD3040

PAA **LRS6002****Straight Lever****Dimensions**

Rose: 50mm dia.
Rose Thickness: 8mm
Lever: 19mm dia.
Lever Length: 139mm



BSEN1906 FD3040

PAA **LRS6003****Curved Lever****Dimensions**

Rose: 50mm dia.
Rose Thickness: 8mm
Lever: 19mm dia.
Lever Length: 139mm



BSEN1906 FD3040

NOTES:

For matching escutcheons and thumbturns see pages 364-366.

CPH6150



D Pull Handle

Dimensions

Lever: 19mm dia.
Centres: 150mm

Variations



FD30/60

Code	Diameter	Centres
CPH6225	19mm	225mm
CPH6300	19mm	300mm
CPH6450 - DDA Compliant	19mm	450mm
CPH6600 - DDA Compliant	19mm	600mm
CPL6225	22mm	225mm
CPL6300	22mm	300mm
CPL6600 - DDA Compliant	22mm	600mm



ESB6005



Blank Escutcheon

Dimensions

Rose: 50mm dia.
Rose Thickness: 8mm



FD30/60





PAA 

ESE6005

Euro Escutcheon

Dimensions

Rose: 50mm dia.
Rose Thickness: 8mm



FD30/60



PAA 

ESP6005

Lever Lock Escutcheon

Dimensions

Rose: 50mm dia.
Rose Thickness: 8mm



FD30/60



PAA 

ESU6005

Oval Escutcheon

Dimensions

Rose: 50mm dia.
Rose Thickness: 8mm



FD30/60

EST6005



**Standard Thumbturn
and Release c/w Indicator**

Dimensions

Rose: 50mm dia.
Rose Thickness: 8mm



FD30/60



EST6025



**Disabled Thumbturn
and Release c/w Indicator**

Dimensions

Rose: 50mm dia.
Rose Thickness: 8mm



FD30/60



DSW6001



**Skirting Mounted Door Stop
on Concealed Rose**

Dimensions

Rose: 32mm dia,



FD30/60





SAA 

LRS9000

22mm Safety Lever
DDA BS8300 Compliant

Dimensions

Rose: 52mm dia.
Rose Thickness: 8mm
Lever: 22mm dia.
Lever Length: 145mm



SAA 

LRS9001

19mm Safety Lever
DDA BS8300 Compliant

Dimensions

Rose: 52mm dia.
Rose Thickness: 8mm
Lever: 19mm dia.
Lever Length: 140mm

Variations

LRS9001U - Unsprung
LRS9001SR - Screw on Rose



SAA 

LRS9002

Straight Lever

Dimensions

Rose: 52mm dia.
Rose Thickness: 8mm
Lever: 19mm dia.
Lever Length: 139mm



NOTES:

For matching escutcheons and thumbturns see pages 368-369.

LRS9003



Curved Lever

Dimensions

Rose: 52mm dia.
Rose Thickness: 8mm
Lever: 19mm dia.
Lever Length: 139mm



LRS9005



Mitred Lever

Dimensions

Rose: 52mm dia.
Rose Thickness: 8mm
Lever: 19mm dia.
Lever Length: 132mm



EST9005



Standard Thumbturn
and Release c/w Indicator

Dimensions

Rose: 52mm dia.
Rose Thickness: 8mm



EST9025



Disabled Thumbturn
and Release c/w Indicator

Dimensions

Rose: 52mm dia.
Rose Thickness: 8mm





SAA 

ESE9005

Euro Escutcheon

Dimensions

Rose: 52mm dia.
Rose Thickness: 8mm



FD30/60



SAA 

ESP9005

Lever Lock Escutcheon

Dimensions

Rose: 52mm dia.
Rose Thickness: 8mm



FD30/60



SAA 

ESU9005

Oval Escutcheon

Dimensions

Rose: 52mm dia.
Rose Thickness: 8mm



FD30/60



SAA 

ESB9005

Blank Escutcheon

Dimensions

Rose: 52mm dia.
Rose Thickness: 8mm



FD30/60

PAD9150

D Pull Handle

Dimensions

Lever: 19mm dia.
Centres: 150mm

Variations



FD30/60



Code	Diameter	Centres
PAD9225	19mm	225mm
PAD9300	19mm	300mm
PFD9150	22mm	150mm
PFD9225	22mm	225mm
PFD9300	22mm	300mm
PFD9450 - DDA Compliant	22mm	450mm
PFD9600 - DDA Compliant	22mm	600mm

OCP9000

Oval Cylinder Pull

Dimensions

78x44mm



FD30/60





SAA 

ECP9000

Euro Cylinder Pull

Dimensions

78x44mm



SAA 

PCP9000

Lever Lock Cylinder Pull

Dimensions

78x44mm



SAA 

RCP9000

Rim Cylinder Pull

Dimensions

78x44mm



SAA 

BCP9000

Blank Cylinder Pull

Dimensions

78x44mm



DSF9030



Floor Mounted Door Stop
Pedestal

Dimensions

Diameter: 30mm



FD30/60



DSF9031



Floor Mounted Door Stop
Large

Dimensions

Diameter: 78mm



FD30/60



DSF9032



Floor Mounted Door Stop

Dimensions

Diameter: 44mm



FD30/60





SAA 

DSW9015

Wall Mounted Door Stop

Dimensions

Diameter: 16mm



FD30/60



SAA 

HCH9012

Flat Coat Hook

Dimensions

70x20mm



FD30/60



SAA 

HCH9013

Flat Hat and Coat Hook

Dimensions

175x20mm



FD30/60

LIP900 I



Safety Lever

Dimensions

Backplate: 154x40mm
Lever: 19mm dia.



Variations



Code	Description
LIP900I/DIN - DDA Compliant	Din Lock
PLB9001 - DDA Compliant	Latch
PLE9001 - DDA Compliant	Euro
PLE9001/72 - DDA Compliant	Euro Din Lock
PLP9001 - DDA Compliant	Lock
PLT9001 - DDA Compliant	Bathroom Turn and Release
PLT9001/78 - DDA Compliant	Bathroom Turn and Release Din Lock
PLU9001 - DDA Compliant	Oval



SAA 



B

FPP43000

Plain Finger Plate

Dimensions

300x75mm

Code	Description	Size	Finish	
FPP43500	Plain Finger Plate	350x75mm	SAA	
FPP45000	Plain Finger Plate	500x75mm	SAA	
FPP46500	Plain Finger Plate	650x75mm	SAA	
FPP43001	Pull Finger Plate	300x75mm	SAA	
FPP43501	Pull Finger Plate	350x75mm	SAA	
FPP45001	Pull Finger Plate	500x75mm	SAA	
FPP46501	Pull Finger Plate	650x75mm	SAA	
FPP43002	Push Finger Plate	300x75mm	SAA	
FPP43502	Push Finger Plate	350x75mm	SAA	
FPP45002	Push Finger Plate	500x75mm	SAA	
FPP46502	Push Finger Plate	650x75mm	SAA	

Variations



SEX4011



Male Symbol



Dimensions

76mm dia.

Variations



FD3066

Code	Description	Size	Finish	
SEX4012	Female Symbol	76mm dia.	SAA	
SEX4014	Shower Symbol	76mm dia.	SAA	
SEX4015	Fire Door Symbol	76mm dia.	SAA	
SEX4016	Fire Door Symbol	76mm dia.	SAA	
SEX4017	Disabled Symbol	76mm dia.	SAA	
SEX4018	Unisex Symbol	76mm dia.	SAA	
SEX4019	Baby Change Symbol	76mm dia.	SAA	
FPA4301	Pull Symbol	75 x30mm	SAA	
FPA4302	Push Symbol	75 x30mm	SAA	

NOTES:

Male, Female and Fire Door Symbols also available in screen printed polished brass.

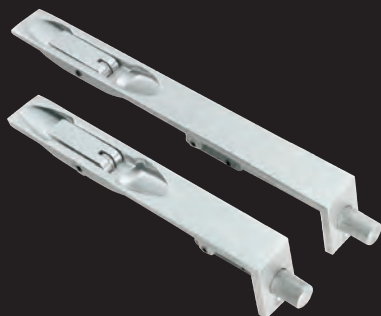

SAA 

FBT4006

Lever Action Flush Bolt

Dimensions

152x19mm

Code	Size
FBT4008	203x19mm
FBT4010	254x19mm
FBT4012	305x19mm

Variations



FD30/60

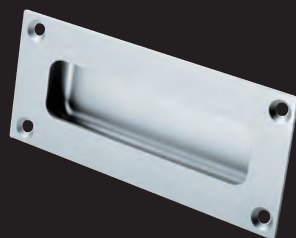

SAA 

FPH4100

Flush Pull

Dimensions

Length: 100mm
Height: 50mm



FD30/60

LPB4004

Contract Aluminium on Backplate - Latch

Dimensions

Backplate: 103x40mm

Variations



Code	Description	Size	Finish	
LPE4004	Euro	154x40mm 47.5mm c/c	SAA	
LPP4004	Lock	154x40mm 57mm c/c	SAA	
LPT4004	Bathroom/Privacy	154x40mm 57mm c/c	SAA	
LPU4004	Oval	154x40mm 48.5mm c/c	SAA	

BBT4100

Straight Barrel Bolt

Dimensions

102x25mm

Variations

BBT4150: 152x32mm

BBT4200: 203x32mm



SAA 





B

SAA21**Aluminium on Backplate Lock****Dimensions**

Backplate: 152x41mm

Variations

FD30/60

Code	Description	Size	Finish	
SAA21Y	Euro Yale	152x41mm 47.5mm c/c	SAA	
SAA21WC	Bathroom	152x41mm 57mm c/c	SAA	
SAA21U	Oval	152x41mm 48.5mm c/c	SAA	
SAA22	Latch	102x41mm 57mm c/c	SAA	

SAA **BBT4100CR****Cranked Barrel Bolt****Dimensions**

102x25mm

Variations**BBT4150CR:** 152x32mm

FD30/60

Product Code Index

003-111	32	AC010-AC011	82	CPSE1170	352-353
112-114	33	AC013-AC020	83	CPSP1170	352-353
115-117	34	AC033-AC050	84	CPST1170	352-353
118-123	35	AC055	99	CPSTL1170	352-353
124-127	36	AQ1-AQ8	21-23	CPSU1170	352-353
129-134	37	AQ11-AQ12	151	CPT1096-CPT1160	333
137-139	38	AQ133	160	CSD1150-CSD1600	354
140-190	39	AQ1NP	187	CSE1005	351
183876	203	AQ25	178	CSH1433	265
184076	203	AQ2NP	187	CSK1058	354
1838100	203	AQ31	95/106	CSL1121-CSL1220	347-350
AA1-AA3	150	AQ34-AQ35	85	CSLP1190-CSLP1191	352-353
AA10	151	AQ39	140	CSP1005	351
AA12	152	AQ40	93/109	CSR1005	354
AA122	175	AQ41	93/158/165	CST1015	350
AA133	169/253	AQ42	142	CSU1005	351
AA145	157	AQ43	140	CYA70445-CYA70470	307
AA14	123	AQ45	158	CYA71140-CYA71150	303
AA15	123	AQ46-AQ47	192	CYA712100-CYA73620	302-306
AA16	124	AQ50	143	CYC71260-CYC71380	312
AA16WRA-B	92/122	AQ81-AQ84	195	CYE71140-CYE73520	309-311
AA17	124	AQ90	167	CYG71364-CYG71380	300
AA18-AA19	125	AQ91	143	CYH71142-CYH71150	295
AA20-AA24	175-176	AQ92-AQ96	144	CYH712100	295
AA245	157	AT5	28	CYH7123240-CYH7124555	296
AA25-AA27	177-178	B12	160	CYH71264-CYH71290	295
AA28	184	BAE5025-BAE5030	287	CYH713100	296
AA29-AA30	114	BAS5025-BAS5030	280	CYH7133240-CYH7136040	297
AA31	106	BB3204-BB4518	200	CYH71364-CYH72146	296-297
AA32	170	BBT1080-BBT1200	343	CYH72264-CYH72380	298
AA33	169/253	BBT4100-BBT4200	378-379	CYH72-S131	299
AA34-AA35	193	BCP1000	345	CYH72-SO31	299
AA345	157	BCP9000	371	CYH72-SP31	299
AA36	121	BD5	29	CYH73525	299
AA38	176	BL1-BL4	196	CYH7PL047-CYH7PLC55	300
AA39	141	BO5	26	CYP71141-CYP73526	292-293
AA4-AA6	158	BR35	192	CYZ70002-CYZ73610	307
AA40	140	BR5	26	DA5	25
AA41	141	BTL1-BTL4	197	DB8-DB24	194
AA42	142	CAB1100-CAB1200	327	DCF2003	273
AA45	199	CEN1433-CEN1443	262	DCP2003-DCP2026	273
AA46	200	CFPT1450-CFPT1600	354	DCS2024-DCS2026	272
AA52-AA56	102/168	CKN1016-CKN1025	333	DCT2024	272
AA55BA	235	CKR1025-CKR1030	334	DCX2017	273
AA60-AA65	167	CL155SGVCB	196	DI5CPBL	28
AA73	133	CN5	31	DK1-DK2	164
AA75	108	CPD1096-CPD1160	332	DK3	165
AA76-AA77	109	CPH1096-CPH1160	333	DK12	163
AA79	191	CPH6150-CPH6600	364	DK13	164
AA81	190	CPL6225-CPL6600	364	DK14-DK18	162
AA810-AA824	190-192	CPRB1170	352-353	DK32	75
AA84-AA86	177	CPRP1170	352-353	DK34	76-77
AA90-AA93	120	CPRT1170	352-353	DK35	72
AA95	122	CPRTL1170	352-353	DK36-DK37	73
AA96-AA97	135	CPRU1170	352-353	DK38-DK39	74
AC003-AC004	161	CPSB1170	352-353	DK4	165

DK42	141	DLS0060-DLS7860	276-277	FG26-FG27	68
DK45	200	DSB8225	193/289	FG3	42
DK5-DK6	166	DSF1030-DSF1031	334	FG4-FG6	89
DK60PVD	79	DSF1032	335	FG7	112
DK7-DK8	134	DSF2020-DSF5020	176	FG8	110
DL1000	163	DSF9030-DSF9032	372	FG9	113
DL100-DL102	67	DSK8000	193/289	FLD8025-FLD8040	281
DL107	112	DSW1015	335	FLE8030	281
DL133	163	DSW6001	366	FLL5025-FLL8040	281
DL16-DL18	61/91	DSW9015	373	FPH1000-FPH1002	331
DL160-DL162	65	DU5	30	FPH1003-FPH1004	332
DL166-DL168	60/92	EA5	29	FPH4100	377
DL170-DL172	53	EBH1-EBH3	201	FPP1300-FPP1650	341
DL180-DL182	59	ECP1000	345	FPP43000-FPP46502	375
DL19	100	ECP9000	371	FR5	30
DL190-DL192	58	EDB5025-EDB5030	274	FRP50-FRP63	201
DL20	174	EDE5025-EDE5030	286	GI5	24
DL219PVD	94	EDS5025-EDS5030	279	H2N11015-H2N1202	260-261
DL250	78	EL11-EL13	54	H2N1424-H2N1446	259
DL252	80-81	EL5	26	H2N1502-H2N1503	261
DL255-DL257	70	EL60-EL62	57	H2N1900-H2N1950	259
DL26-DL27	66	ERO006-ERO008	156	H3N1101-H3N1107	258-259
DL260-DL262	70	ES34-ES35	185	HBS1050	344
DL263-DL267	66	ESB005	153	HCH1010	335
DL270-DL272	66	ESB5025-ESB5030	275	HCH1011-HCH1013	336
DL273-DL275	69	ESB6005	364	HCH1014-HCH1016	337
DL277-DL279	52	ESB9005	369	HCH1017-HCH1018	338
DL280-DL282	53	ESE5025-ESE5030	286	HCH9012-HCH9013	373
DL285-DL287	55	ESE6005	365	HDBB1-HDBB4	202
DL290-DL292	58/91	ESE9005	369	HDPBW8-HDPBW21	202
DL3	42	ESP005	153	HDSSW2-HDSSW5	202
DL30-DL31	62	ESP6005	365	HDSW1-HDSW20	202
DL32	40	ESP9005	369	HIN1322	265
DL300-DL302	60	ESS5025-ESS5030	279	HIN13225	263
DL340-DL346	50	EST004-EST005	154-155	HIN14325	202/263
DL347-DL348	100	EST6005	366	HIN1433	263/264
DL350-DL356	51	EST6025	366	HIN424	267
DL370	103	EST9005	368	HINFP1-HINFP4	203/254
DL380-DL382	59	EST9025	368	HINLP1-HINLP4	203
DL410-DL412	52/90	ESU005	154	HIP14325	266
DL44	135	ESU6005	365	HIW13215-HIW14325	266-267
DL450-DL456	51	ESU9005	369	HL3-HL11	186
DL460-DL462	65	EV5	23	HMB-HM6	186
DL5025-DL5050	198	FBH1	201	HRB1000	344
DL51	139	FBH2	201	HSB1038	344
DL54-DL55	64	FBT1008	346	HSD3-HSD4	203
DL56	41	FBT4006-FBT4012	377	HSD35	203
DL611	126	FG1	68	INT1102-INT1443	262
DL64-DL65	64	FG10	181	IR1-IR3	54
DL66	40	FG11	115	KPP1590-KPP1915	342
DL67-DL68	61/90	FG15	111	LCP1000	280
DL75-DL76	63	FG16	126	LDB5525-LDB5530	274
DL77	40	FG17S	134	LDE5325-LDE5530	288
DL9	113	FG1-FG2	68	LDS5325-LDS5530	278
DLD5030-DLD5050	199	FG20-FG21	179	LE01-LE03	217
DLE0055-DLE7855	284-285	FG25	112	LE04	216

Product Code Index

LE05	218	LF5591-LF5592	238	M49	96
LE06	220	LF5594-LF5595	231	M51	99
LE07-LE08	218	LF56NP92	227	M60	97
LE09	220	LIP9001	374	M61	98
LE11-LE13	219	LM5	24	M63-M64	62
LE14	222	LPB4004	378	M65	41
LE15-LE17	221	LPE4004	378	M67-M68	65
LE18-LE26	215	LPP4004	378	M73	139
LE28-LE30	216	LPT4004	378	M78	101
LE31	220	LPU4004	378	M86	188
LET10100-LET1050	338	LS56000-LS56003	363	MB1	183
LF1006	242	LS59000-LS59002	367	MB10	111
LF34	242	LS59003-LS59005	368	MB2	182
LF5101	245	LSB5525-LSB5530	274	MB24-MB28	184
LF5102	250	LSE5225-LSE5330	288	MB3	180
LF5103	246	LSS5325-LSS5530	278	MB37	121
LF5110-LF5115	230	LVO2-LV07	224	MB4	182
LF5116-LF5118	228	LV11-LV13	225	MB40	128
LF5121-LF5130	254-255	LV14	226	MCN5025	280
LF5260	247	LV19-LV24	223	ML051500-ML051503	323
LF5266	248	LW02	212	ML110921	191
LF5501-LF5503	228	LW05	211	ML110924	191
LF5504-LF5506	227	LW07	210	ML110928	191
LF5507-LF5509	229	LW08-LW09	212	MP5	27
LF55101	249	LW12	210	M55-MS11	67
LF55102-LF55103	239	LW14	211	N0-N9	95/107
LF5515	255	LW17	213	NA-ND	107
LF5516-LF5518	229	LW18-LW26	209	NI5	25
LF5519-LF5521	255	LW27	214	NPH1-NPH3	201
LF5522	254	LW29	213	NUM10100-NUM10508	339
LF5523	236	LX03	208	OCP1000	344
LF5524-LF5525	235	LX04	205	OCP9000	370
LF5526	251	LX05-LX14	207	OD8-OD24	194
LF5527	253	LX21-LX25	205	ODE5025-ODE5030	287
LF5528-LF5530	252	M1000	159	ODS5025-ODS5030	279
LF5531	234	M1001	88	OSE5025-OSE5030	286
LF5532-LF5533	233	M1002	171	OSS5025-OSS5030	280
LF5534	237	M140NP	188	PAC1225-PAC1600	321
LF5535	251	M219-M220	96-97	PAD1150-PAD1600	320
LF5536	237	M30	63	PAD9150-PAD9300	370
LF5537	243	M304	101	PAM1225-PAM1300	322
LF5538	234	M30-M31	63	PAT1225-PAT1300	322
LF5539	232-233	M32	41	PBC1300	321
LF5540	243	M33	98	PBD1225-PBD1300	320
LF5541-LF5542	244	M34-M35	86-88	PBG1250	321
LF5543	236	M36	93/101/102	PBH1-PBH2	201
LF5544-LF5545	241	M37	103	PBT1225-PBT1300	322
LF5546	232	M38	94/108	PCC1450-PCC1600	321
LF5547	257	M39	172-173	PCD1600-PCD1800	320
LF5548	256	M40	109	PCM1450-PCM1600	322
LF5549	239	M41-M42	159	PCP1000	345
LF5550	231	M43	105	PCT1600-PCT11800	322
LF5563	252	M44	133	PE5	24
LF5574	248	M45	104	PF100-PF105	116-117
LF5575	247	M46	105	PF106-PF107	119
LF5590	240	M48	86	PF108	127

PF109-PF110	118	SW102-SW104	325	SZS080-SZS120	18
PFC1300	321	SW105-SW107	326	SZS12NP	190
PFD1225-PFD1300	320	SW11-SW12	314	SZS130-SZS140	19
PFD9150-PFD9600	370	SW120	316	SZS160-SZS360	20
PFT1225-PFT1300	322	SW121	317	SZS44-SZS73	129
PH003-PH116	360	SW122-SW127	314-315	TL1-TL4	197
PH118-PH127	361	SW13	314	TL7-TL9	198
PH225-PH300	362	SW14	315	TLD5030-TLD5850	282
PL3-PL12	186	SW140-SW141	317	TLE5025-TLE5030	289
PLB9001	374	SW15-SW17	314-315	TLS5025-TLS8030	282
PLE9001	374	SW18-SW19	316	TO5	30
PLG	43	SW3041-SW3043	328	ULE5025-ULE5030	287
PLP9001	374	SW3044-SW3046	329	ULS5025-ULS5030	282
PLT9001	374	SW3047-SW3049	330	UO5	28
PLU9001	374	SWKNR	327	URB55025-URB55030	283
PLW	43	SWLP123/SWOB	318	URES5025-URES5030	283
PX5	27	SWNP11	323	URLS5325-URLS5530	283
PZD1150-PZD1300	320	SWNP120	323	UROS5025-UROS5530	283
PZT1150	322	SWNP40-SWNP41	324	V1005-V1008	136-138
QU5B	31	SWOE	318	WSB8125	289
RBH1433	265	SWOP	318	WD5	27
RCB8260	290	SWOT	318	WF11	137
RCN8160-RCN8360	291	SWOU	318	WF12	133
RCP1000	346	SWP120	320	WF14	135
RCP9000	371	SWP17	319	WF15-WF17	136
RDE8043	289	SWP18	319	WF21	131
RLE8043	289	SWP19	319	WF22-WF25	132
RSE8053-RSE8064	289	SZC001-SZC003	145	WF30-WF35	130-131
RSL5030	278	SZC004	146	XDB5760	268
SA5	25	SZC010	8	XDD5760	268
SAA21-SAA22	379	SZC011-SZC013	44	XDL5760	268
SCH14325	264	SZC020	8	XIA5000-XIA5012	270
SCP8-SCP10	203	SZC021-SZC023	44	XIA5014-XIA5017	268
SEB7	203	SZC030	8	XID5120-XID5760	270
SEX1011-SEX1021	340	SZC031-SZC033	45	XIT5120	270
SEX4011-SEX4019	376	SZC040	9	XIT5760	270
SL1-SL4	191	SZC041-SZC043	45	XSA5002-XSA5012	269
SOC4068	346	SZC050	9	XSD5760	269
SP104	168	SZC051-SZC053	46	XSL5760	269
SP5	31	SZC330	9	ZET3025	155
SPB8-SPB10	203	SZC340	10		
SPES	185	SZM001-SZM003	147		
SSD1415-SSD1460	358	SZM001SQ-SZM004SQ	148-149		
SSE1405	357	SZM004	149		
SSF1415-SSF1460	359	SZM014-SZM026	11		
SSL1401-SSL1403	355	SZM066-SZM068	47		
SSL1404-SSL1406	356	SZM100-SZM210	12-13		
SSM1415-SSM1460	359	SZM220-SZM230	14		
SSP1405	357	SZM241-SZM243	48		
SSR1405	358	SZM250-SZM370	14-15		
SST1415	358	SZM371-SZM373	47		
SSU1405	357	SZM380	15		
STL1-STL4	197	SZS004	149		
SU5	29	SZS010-SZS070	16-17		
SW10	314	SZS01NP	189		
SW101	324	SZS03NP	189		

Product Index

A			F	
Aluminium furniture	363-379		Fan light catch	141
B			Finger plates	80-81/116-119/171-174/249-250/ 341/375
Ball Bearing hinges	202		Flush bolts	190/346/377
Barrel bolts	200/343/378-379		Flush pulls	167/331-332/377
Bath racks	217		Flush ring pull	201
Bathroom bolts	192		G	
Bathroom locks	196		Gate latches	257
Bell pushes	95/106/114/237		Glass shelves	205/209/215-216/223
Black antique furniture	227-257		Grab rails	205/216
Butt hinges	202-203		Gravity door catches	200
C			H	
Cabin hooks	167/252/327		Handrail brackets	177/344
Cabinet pull	332-333		Handrail saddle	344
Cabinet knob	333-334		Hat and coat hooks	176-178/184/251-253/ 335-338/373
Casement fasteners	129-131/136-139/241-244		Hinge fronts	254-255
Casement stays	129-134/241-244		Hinges (Carlisle Brass)	201-203/254-255
Centre door knobs	94-99/111/231		Hinges (Enduro)	262-264
Crystal door knobs	82-84		Hinges (Enduromax)	258-261
Contract stainless steel range	347-354		Hinges (Eurospec)	265-267
Cylinders	292-313		Hinge liner	262
Cylinder pulls	93/109/113/236/344-346/370-371		I	
D			Ice crystal collection	82-84
Dead bolts	199/282		Indicator bolts	192-193
Delamain range	69-81		Inner tidies	102
Deleau Bathroom Fittings	205-226		K	
Digital door lock	196		Kickplates	342
Doctors knocker	104-105		Knob furniture	72-79/82-89
Door bolts	194-195/252		Knob furniture on backplate	69-71/89
Door chains	108/237		L	
Door closers	199/272-273		Letterbox	191
Door knockers	94/103-105/108-111/115/238-240		Letter plates	93/100-102/112/191/235-236
Door stops	175-176/254/259/334-335/366/372-373		Letter tidies	102/168/235
Door studs	239		Letters	107/338
Door viewers	109		Levers on backplate	44-68/90-92/227-230/318/ 352-353/374/378-379
E			Levers on rose	8-43/314-317/328-329/347-350/ 355-356/363/367-368
Easi-keep latch	200		Levers (Designer)	21-39
Easy clean sockets	192		Liquid soap dispensers	214
Ejma pins	136		Locking casement stay pin	136
Escutcheons	93/145-150/153-154/157-159/179/ 232-234/324-325/351/357/364-365/369		Locks (British Standard)	274-275
Espagnolette bolts	185			
Espagnolette fasteners	131-132/243			
Espagnolette handles	137			
External door furniture	90-115/235-240			

Locks (Architectural Din)	276-277
Locks (Architectural)	278-282
Locks (Universal Replacement)	283
Locks (Contract Din)	284-285
Locks (Contract)	286-289
Loose pin hinges	203
Ludlow foundries range	227-257

M

Mortice knob furniture	85-89/231/327
Mortice latches	197

N

Narrow plate levers	187-190/227/323-324
Nightlatches	290-291
Numerals	95/107/239/339

O

Oval mirrors	213
Overhead towel racks	216

P

Padlocks	300
Panic Hardware	268-271
Paper holders	206/210/212/218/220/224
Piano hinges	201
Pivot Set	259
Porcelain furniture	43/76-77
Postal knockers	101/112/236
Pull handles	92/116-128/245-248/358-362 319-322/354/370

Q

Quadrant arm stays	134
--------------------	-----

R

Rebate sets	198
Rim deadlock	289
Rim knob furniture	88
Robe hooks	177-178/208/212/217/224
Roller arm stays	134

S

Sash fasteners	140-141
Sash handles	135
Sash lifts	142-143
Sash pulleys	143-144
Security door bolts	193/289

Soap trays	206/210/219/221/225
Square stainless steel range	355-359
Steelworx	314-346
Suffolk latches	256
Symbols	340-376

T

Thumb latch sets	251
Toilet brush holders	207/211/222/226
Toothbrush holders	212
Towel rails	205/209/215/223
Towel rings	207/211/218
Triangular trays	213/221
Tubular latches	197-198/282/289
Tumbler holders	206/210/219/225
Turns	169/253
Turn and Releases	146/149/151-152/154-156/ 160-164/168-170/179/253/326/330/ 350/358/366/369

V

Ventilators	186
-------------	-----

W

Washed hinges	202
Window fittings	129-144/241-244

All Knex lever furniture is suitable for use on 1/2 hour fire doors to BS EN 1634-1 2000. All Knex products are covered by a 10 year mechanical guarantee.

All items marked ***SPECIAL ORDER** are products which are available ex-stock. Under normal circumstances orders for special items have a 3-4 week delivery period and a minimum order quantity. In some instances the delivery period can be 4-12 weeks. Delivery periods will be confirmed by our sales department. We will endeavour to meet the delivery date specified.



Products available in blister pack. All sizes/finishes may not be available.

All sizes are approximate and we reserve the right to change them where necessary and without notice. Colours may vary slightly from the actual product due to photography and printing techniques. All errors and omissions excepted.

Knex AI Ltd.
Unit 70, Basepoint
Metcalf Way
Crawley
West Sussex
RH11 7XX

www.knexai.co.uk
sales@knexai.co.uk

Tel: 01293 817708
Fax: 01293 817709

